

## GINNASTICA

Una linea completa di attrezzature ed articoli per la pratica delle varie discipline della **ginnastica scolastica**, della **ginnastica artistica**, **aerobica** e **ritmica** con una selezione di attrezzature ed **articoli omologati FIG per competizioni**. La categoria comprende altresì articoli per la **ginnastica in età pre-scolare** e per la **ginnastica nella terza età** oltre ad accessori per **danza**, **Yoga** e **Pilates**. Gli ultimi capitoli sono dedicati infine al **fitness** ed alla **boxe**.



## GYMNASTICS

*A complete range of equipment and accessories for practicing the disciplines of **standard school's gymnastics** as well as **artistic**, **aerobic** and **rhythmic gymnastics**.*

*A selection of **FIG approved equipment** is included. This category includes, as well products for **junior** and **senior gymnastics**, also **accessories for ballet**, **Yoga** and **Pilates**. The last titles are dedicated to **fitness** and **boxing**.*



1

## Anelli Rings



S00002

### S00002

Coppia anelli di legno lamellare  
Pair of varnished laminated wood rings



S00004

### S00004

Coppia funi di canapa per anelli  
(anelli esclusi)  
Pair of hemp ropes suitable for rings  
(rings not included)



S00006

### S00006

Coppia funi di nylon con snodi per anelli  
(anelli compresi)  
Pair of jointed nylon ropes suitable for  
rings (rings included)



S00008

### S00008

Mensola a muro per sospensione anelli  
ad altezza fissa (anelli e funi esclusi)  
Wall mounted support sustaining rings  
at fixed height (rings and ropes not  
included)



S00010

### S00010

Mensola a muro per sospensione  
anelli ad altezza regolabile (anelli e funi  
esclusi)  
Wall mounted support sustaining rings  
at adjustable height (rings and ropes not  
included)

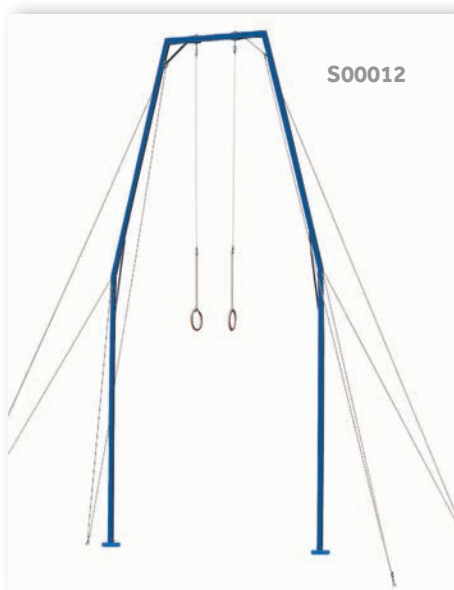

S00012

### S00012

Castello per anelli di acciaio  
verniciato (anelli e funi esclusi)  
Varnished steel rings' frame  
(rings and ropes not included)

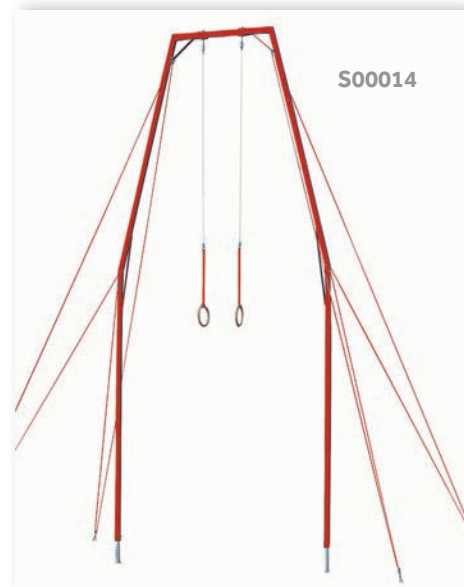

S00014

### S00014

Castello per anelli omologato  
FIG per competizioni (anelli e funi  
compresi)  
Varnished steel rings' frame FIG  
approved for competition (rings and  
ropes included)



S00016

### S00016

Carrello porta magnesio in acciaio  
verniciato, mobile su ruote  
Varnished steel chalk container  
mobile on wheels



S00018

### S00018

Magnesio in confezione di 8 pani  
Chalk blocks in package of 8 pcs

2

## Assi e travi di equilibrio Balance beams

### S00052

Asse di equilibrio in legno, altezza fissa cm 30, lunghezza mt 3  
Wooden training balance beam, 3 mt long, fixed height 30 cm

### S00054

Asse di equilibrio in legno, altezza fissa cm 30, lunghezza mt 4  
Wooden training balance beam, 4 mt long, fixed height 30 cm



S00056

S00056  
ZOOM

### S00056

Asse di equilibrio in legno, altezza fissa cm 30, lunghezza mt 5  
Wooden training balance beam, 5 mt long, fixed height 30 cm



S00058

### S00058

Asse di equilibrio in legno, altezza regolabile cm 30/50, lunghezza mt 5  
Wooden training balance beam, 5 mt long, adjustable height 30/50 cm

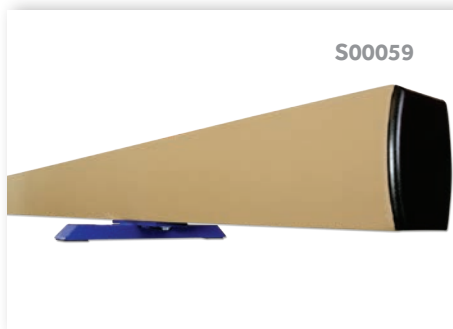

S00059

### S00059

Trave di equilibrio in alluminio rivestito, supporto a terra, lunghezza mt 5  
Aluminium balance beam padded and covered, 5 mt long, ground level support



S00060

### S00060

Trave di equilibrio in alluminio rivestito ad altezza fissa cm 50, lunghezza mt 5  
Aluminium balance beam padded and covered, 5 mt long, fixed height 50 cm



S00061

### S00061

NEW

Trave di equilibrio in alluminio rivestito ad altezza fissa cm 125, lunghezza mt 5  
Aluminium balance beam padded and covered, 5 mt long, fixed height 125 cm



S00062

### S00062

Trave di equilibrio in alluminio rivestito ad altezza regolabile cm 80/120, lunghezza mt 5  
Aluminium balance beam padded and covered, 5 mt long, adjustable height 80/120 cm



S00064



S00064 - ZOOM

### S00064

Trave di equilibrio in alluminio rivestito ad altezza regolabile cm 50/120, lunghezza mt 5, a norme FIG  
Aluminium balance beam padded and covered, 5 mt long, adjustable height 50/120 cm, in accordance to FIG rules



S00066

**S00066**

Trave di equilibrio omologata FIG per competizioni ad altezza regolabile cm 90/140, lunghezza mt 5

*Aluminium balance beam FIG approved for competition, 5 mt long, adjustable height 90/140 cm*

S00068

**S00068**

Carrello in acciaio verniciato per trasporto trave

*Varnished steel trolley for balance beam*

S00070

**S00070**

Rivestimento per trave di skay scamosciato

*Removable cover for beam's body made of suede synthetic leather*

3

### Cavalli, cavalline, corsie di rincorsa Vaulting and pommel horses, vaulting bucks, run up tracks



S00102

**S00102**

Cavallo per volteggio senza maniglie, rivestito di cuoio naturale, altezza regolabile

*Vaulting horse, covered with natural leather, adjustable height*

**S00104**

Cavallo per volteggio senza maniglie, rivestito di cuoio sintetico, altezza regolabile

*Vaulting horse, covered with synthetic leather, adjustable height*



S00106

**S00106**

Cavallo con maniglie, rivestito di cuoio naturale, altezza regolabile

*Pommel horse, covered with natural leather, adjustable height*

**S00108**

Cavallo con maniglie, rivestito di cuoio sintetico, altezza regolabile

*Pommel horse, covered with synthetic leather, adjustable height*

**S00110**

Cavallo olimpionico per volteggio, rivestito di finta pelle scamosciata, altezza regolabile

*Olympic vaulting horse, covered with suede like leather, adjustable height*



S00112

**S00112**

Cavallo olimpionico con maniglie, rivestito di finta pelle scamosciata, altezza regolabile

*Olympic pommel horse, covered with suede like leather, adjustable height*



S00114

**S00114**

Cavallo con maniglie omologato FIG per competizioni, rivestito di cuoio naturale, altezza regolabile

*Pommel horse FIG approved for competition, covered with natural leather, adjustable height*



S00116

**S00116**

Coppia maniglie per cavallo in poliammide e vetroresina

*Pair of polyamide and fibreglass pommels for pommel horse*

**S00122**

Cavallina regolamentare, rivestita di cuoio naturale, altezza regolabile (Bassa)

*Vaulting buck, covered with natural leather, adjustable height (Low)*

**S00123**

Cavallina regolamentare, rivestita di cuoio naturale, altezza regolabile (Alta)

*Vaulting buck, covered with natural leather, adjustable height (High)*



S00128

**S00128**

Corsia di rincorsa arrotolabile in poliuretano e moquette, spessore mm 25, dimensioni mt 25x1

*Rollable run-up track made of polyurethane foam covered with carpet, thickness 25 mm, dimensions 25x1 mt*



S00120

**S00120**

Tavolo per volteggi omologato FIG per competizioni, rivestito in materiale bicolore ed antiscivolo, regolabile in altezza

*Vaulting table FIG approved for competition, bi-coloured and anti-slip body, central leg adjustable in height*



S00124

**S00124**

Cavallina regolamentare, rivestita di cuoio sintetico, altezza regolabile (Bassa)

*Vaulting buck, covered with synthetic leather, adjustable height (Low)*

**S00125**

Cavallina regolamentare, rivestita di cuoio sintetico, altezza regolabile (Alta)

*Vaulting buck, covered with synthetic leather, adjustable height (High)*

**S00130**

Corsia di rincorsa arrotolabile in poliuretano e moquette, spessore mm 35, dimensioni mt 15x2

*Rollable run-up track made of polyurethane foam covered with carpet, thickness 35 mm, dimensions 15x2 mt*

S00132

**S00132**

Cubone per volteggi, dimensioni cm 200x100x80, densità 16

*Soft vaulting cube, dimensions 200x100x80 cm, density 16*

4

**Parallele - Parallel and asymmetric bars**

S00152

**S00152**

Parallela maschile in acciaio verniciato su basamento pesante, staggi di legno lamellare regolabili in altezza e larghezza

*Parallel bars, varnished steel construction with heavy base, laminated wood bars adjustable in height and width*



S00154

**S00154**

Parallela maschile omologata FIG per competizioni, robusta struttura di acciaio verniciato, regolazione in altezza e larghezza degli staggi

*Parallel bars FIG approved for competition, reinforced varnished steel frame, easy adjustment of bars' height and width*



S00156

**S00156**

Parallela asimmetrica femminile in acciaio verniciato su basamento pesante, staggi di legno lamellare regolabili in altezza e larghezza

*Asymmetric bars, varnished steel construction with heavy base, laminated wood bars adjustable in height and width*



S00158

**S00158**

Parallela asimmetrica femminile omologata FIG per competizioni, struttura di acciaio verniciato con tiranti, regolazione in altezza e larghezza degli staggi

*Asymmetric bars FIG approved for competition, varnished steel construction with cables, bars adjustable in height and width*



S00160

**S00160**

Parallela scolastica da allenamento, modello a losanga, staggi in legno lamellare ad altezza fissa

*Practice parallel bars with light varnished steel structure on wooden base, laminated wood bars at fixed height*

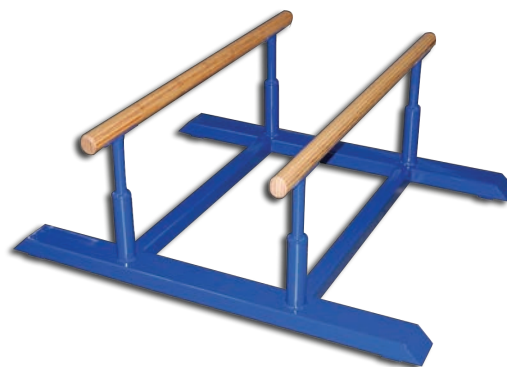

S00162

**S00162**

Mini parallela da allenamento ad altezza fissa cm 40, staggi in legno lamellare lunghezza cm 120

*Mini parallel bars for training, fixed height 40 cm, laminated wood bars length 120 cm*

S00164

**S00164**

Staggio per parallela in legno lamellare, lunghezza cm 350

*Laminated wood bar for parallel and asymmetric bars, 350 cm long*

S00168



**S00168**  
Carrello in acciaio verniciato per trasporto parallele S00152 e S00156  
*Varnished steel trolley for parallel and asymmetric bars S00152 and S00156*

5

**Pedane elastiche,  
pedane corpo libero**  
**Springboards,  
gymnastic floors**

S00202

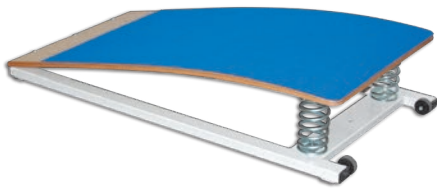

**S00202**  
Pedana elastica a molle di acciaio, piano di battuta ricoperto di moquette, telaio con ruote  
*Springboard equipped with 2 steel springs, carpet covered surface, ground frame with transport wheels*

S00204



**S00204**  
Pedana elastica con piano di battuta di legno  
*Springboard with wooden surface*

S00206



S00206

Pedana elastica con piano di battuta ricoperto di gomma  
*Springboard with rubber covered surface*

S00208



**S00208**  
Pedana elastica con piano di battuta ricoperto di moquette  
*Springboard with carpet covered surface*

S00210



**S00210**  
Pedana elastica a doppio molleggio, piano di battuta rivestito di moquette  
*Double effort springboard with carpet covered surface*

S00211



**S00211**  
Protezione frontale a "U" per pedana elastica, in gomma rivestita PVC  
*Soft pad "U" shaped for springboard, made in foam covered PVC*

S00212

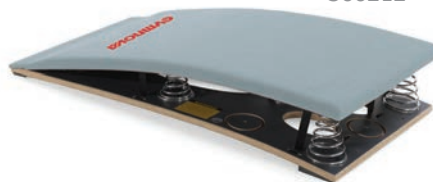

**S00212**  
Pedana elastica olimpionica omologata FIG per competizioni, piano di battuta imbottito e rivestito  
*Olympic springboard FIG approved for competition with padded and carpet covered surface*



S00214

S00214

Pedana per ginnastica artistica omologata FIG per competizioni, dimensioni mt 14x14, spessore totale cm 14,5

*Artistic gymnastic exercise floor FIG approved for competition, dimensions 14x14 mt, total thickness 14.5 cm*

S00216

Pedana per allenamento corpo libero e ginnastica artistica con dimensioni mt 14x14, spessore mm 35, in rotoli da cm 200

*Rollable mat floor for practicing artistic gymnastic exercises, dimensions 14x14 mt, thickness 35 mm, in rolls of 200 cm*

S00218



S00218

Tappeto arrotolabile per pedana corpo libero in poliuretano e moquette, spessore mm 25, dimensioni mt 25x1  
*Rollable gymnastic exercises mat, polyurethane foam covered with carpet, thickness 25 mm, dimensions 25x1 mt*

S00220

Tappeto arrotolabile per pedana corpo libero in poliuretano e moquette, spessore mm 35, dimensioni mt 15x2  
*Rollable gymnastic exercises mat, polyurethane foam covered with carpet, thickness 35 mm, dimensions 15x2 mt*

S00221

Rotolo di Velcro di colore rosso per unione tappeto arrotolabile, altezza cm 10, lunghezza mt 20  
*Roll of red Velcro for connecting rollable gymnastic mats, height 10 cm, length 20 mt*

6

Sbarre orizzontali per volteggi - *Horizontal high bars***S00252**

Sbarra orizzontale per volteggi regolabile in altezza, fissaggio a terra con tiranti

*Horizontal high bar suitable for vaulting, adjustable in height, to be fixed with cables*

**S00254**

Sbarra orizzontale per volteggi omologata FIG per competizioni, regolabile in altezza, fissaggio a terra con tiranti

*Horizontal high bar suitable for vaulting FIG approved for competition, adjustable in height, to be fixed with cables*

7

Appoggi e ceppi - *Baumann supports and blocks*

S00302



S00304

**S00302**

Coppia appoggi Baumann di legno massiccio verniciato

*Pair of Baumann supports in varnished wood*

**S00304**

Coppia ceppi Baumann di legno massiccio verniciato

*Pair of Baumann blocks in varnished wood*

S00306

**S00306**

Mensola in acciaio verniciato porta ceppi e appoggi da fissare a parete

*Varnished steel wall rack for Baumann supports and blocks*



8

**Armadi e mobili porta attrezzi - Equipment lockers and trolleys**

S00352

**S00352**

Armadio porta attrezzi di lamiera verniciata ad ante battenti con vano interno porta valori, dimensioni cm 100x45x200

*Equipment locker made from varnished sheet steel with shelves and lockable compartment for valuables inside, dimensions 100x45x200 cm*



S00354

**S00354**

Armadio porta attrezzi di lamiera verniciata ad ante battenti con 4 ripiani, dimensioni cm 100x45x200

*Equipment locker made from varnished sheet steel with 4 shelves inside, dimensions 100x45x200 cm*



S00356

**S00356**

Armadio porta attrezzi di lamiera verniciata ad ante scorrevoli con 4 ripiani, dimensioni cm 120x45x200

*Equipment locker made from varnished sheet steel with 4 shelves inside and sliding doors, dimensions 120x45x200 cm*

S00358

**S00358**

Armadio porta attrezzi con pareti in rete metallica zincata e 2 ripiani, dimensioni cm 155x75x160 mobile su ruote, smontabile

*Equipment trolley mobile on wheels, made of galvanized steel mesh walls with 2 shelves, dimensions 155x75x160 cm, can be dismantled*



S00360

**S00360**

Mobile porta attrezzi ginnici a 3 ripiani, in acciaio verniciato

*Varnished steel gymnastic equipment trolley with 3 shelves*



S00362

**S00362**

Mobile porta attrezzi ginnici a 3 ripiani, in acciaio verniciato, mobile su ruote  
*Varnished steel gymnastic equipment trolley with 3 shelves, mobile on wheels*



S00366

**S00366**

Carrello porta attrezzi di legno massiccio a 3 ripiani, mobile su ruote girevoli, completo di maniglie, dimensioni totali cm 95x70x100  
*Wooden equipment trolley with 3 shelves, mobile on pivoting wheels, complete with handles, total dimension 95x70x100 cm*

9

**Bastoni - Gymnastic sticks****S00402**

Bastone di legno, diametro mm 24, lunghezza cm 80  
*Wooden gymnastic stick, diameter 24 mm, length 80 cm*

**S00404**

Bastone di legno, diametro mm 24, lunghezza cm 90  
*Wooden gymnastic stick, diameter 24 mm, length 90 cm*

**S00405**

Bastone di legno, diametro mm 24, lunghezza cm 100  
*Wooden gymnastic stick, diameter 24 mm, length 100 cm*

**S00406**

Bastone di legno, diametro mm 24, lunghezza cm 120  
*Wooden gymnastic stick, diameter 24 mm, length 120 cm*

**S00407**

Bastone di legno, diametro mm 24, lunghezza cm 150  
*Wooden gymnastic stick, diameter 24 mm, length 150 cm*

**S00408**

Bastone di plastica, diametro mm 25, lunghezza cm 80  
*Plastic gymnastic stick, diameter 25 mm, length 80 cm*

**S00411**

Bastone di plastica, diametro mm 25, lunghezza cm 100  
*Plastic gymnastic stick, diameter 25 mm, length 100 cm*

**S00412**

Bastone di plastica, diametro mm 25, lunghezza cm 120  
*Plastic gymnastic stick, diameter 25 mm, length 120 cm*

S00414

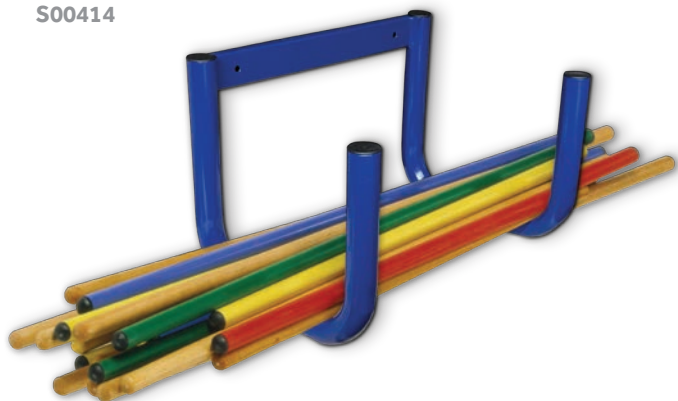
**S00414**

Mensola in acciaio verniciato porta bastoni da fissare a parete

*Varnished steel wall rack for gymnastic sticks*

10

### Cerchi Gymnastic hoops

**S00452**

Cerchio di nylon colorato, sezione piatta, diametro cm 40

*Coloured nylon hoop, flat section, diameter 40 cm*

**S00454**

Cerchio di nylon colorato, sezione piatta, diametro cm 50

*Coloured nylon hoop, flat section, diameter 50 cm*

**S00456**

Cerchio di nylon colorato, sezione piatta, diametro cm 60

*Coloured nylon hoop, flat section, diameter 60 cm*

**S00458**

Cerchio di nylon colorato, sezione piatta, diametro cm 70

*Coloured nylon hoop, flat section, diameter 70 cm*

**S00460**

Cerchio di nylon colorato, sezione piatta, diametro cm 80

*Coloured nylon hoop, flat section, diameter 80 cm*

**S00464**

Cerchio di plastica colorato, sezione tonda, diametro cm 60

*Coloured plastic tubular hoop, round section, diameter 60 cm*

**S00466**

Cerchio di plastica colorato, sezione tonda, diametro cm 70

*Coloured plastic tubular hoop, round section, diameter 70 cm*

**S00468**

Cerchio di plastica colorato, sezione tonda, diametro cm 80

*Coloured plastic tubular hoop, round section, diameter 80 cm*

**S00470**

Cerchio di plastica colorato, sezione tonda, diametro cm 90

*Coloured plastic tubular hoop, round section, diameter 90 cm*

S00472

**S00472**

Mensola in acciaio verniciato porta cerchi da fissare a parete

*Varnished steel wall rack for gymnastic hoops*

11

### Clavette Gymnastic clubs



S00502

**S00502**

Coppia clavette di legno verniciato, altezza cm 31  
*Pair of varnished wooden clubs, height 31 cm*

**S00504**

Coppia clavette di legno verniciato, altezza cm 35  
*Pair of varnished wooden clubs, height 35 cm*

**S00506**

Coppia clavette di legno verniciato, altezza cm 40  
*Pair of varnished wooden clubs, height 40 cm*

**S00510**

Coppia clavette di nylon colorato, secondo norme FIG  
*Pair of coloured nylon clubs, in accordance to FIG rules*

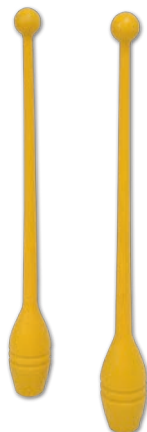

S00510



S00512

**S00512**

Mensola in acciaio verniciato porta clavette da fissare a parete  
*Varnished steel wall rack for gymnastic clubs*

12

### Funi, funicelle Ropes



S00552

**S00552**

Fune per tiro alla fune, con indicazioni colorate, lunghezza mt 15  
*Tug of war rope, marked sections, length 15 mt*

**S00554**

Fune per tiro alla fune, con indicazioni colorate, lunghezza mt 20  
*Tug of war rope, marked sections, length 20 mt*

**S00556**

Fune per tiro alla fune, con indicazioni colorate, lunghezza mt 25  
*Tug of war rope, marked sections, length 25 mt*

**S00558**

Funicella con ingrossamento centrale  
*Hemp skipping rope with thick reinforced centrepiece*



S00558



S00560

**S00560**

Funicella con ingrossamento centrale e manopole  
*Hemp skipping rope with thick reinforced centrepiece and handles*

**S00562**

Funicella, di cotone colorato, piombata  
*Coloured center leaded cotton skipping rope*



S00562

S00564

**S00564**

Mensola in acciaio verniciato porta funicelle da fissare a parete  
*Varnished steel wall rack for skipping ropes*

## NOTE

Materassi con rivestimento composito a prevalenza di PVC "Carbon", resistente alla trazione, alla rottura ed alla lacerazione secondo la norma UNI4818, resistente al fuoco in classe 2 secondo la norma UNI9475, con trattamento antibatterico. Dotati di maniglie in PVC, zip e sfiati (per materassi con spessore superiore a cm 10). Interno in gomma espansa con densità "d." variabile in base al diverso spessore del materasso (densità 80 per materassi con spessore cm 5, densità 60 per materassi con spessore cm 10, densità 16 per materassi con spessore superiore a cm 10). Per densità si intende il rapporto kg/m<sup>3</sup>.

*Gym mats are covered by a composite PVC fabric "Carbon", resistant to traction, breakage and laceration complying to UNI4818 standard, and fireproof resistant class 2 complying to UNI9475 standard, anti-bacterial treated. Equipped with PVC handles, zip and breather holes (on mats with thickness over 10 cm). The interior is made of expanded foam with different densities "d." depending on the sheet's thickness (density 80 for mats with thickness 5 cm, density 60 for mats with thickness 10 cm, density 16 for mats with thickness over 10 cm). Density corresponds to ratio kg/m<sup>3</sup>.*

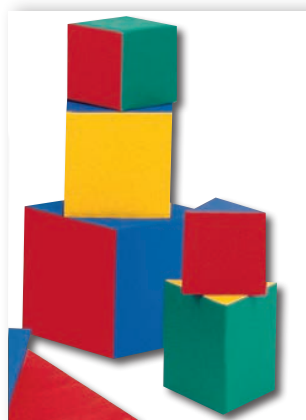

Rivestimento disponibile anche di colore **giallo**, **verde** e **rosso**.

*PVC fabric also available in yellow, green and red.*

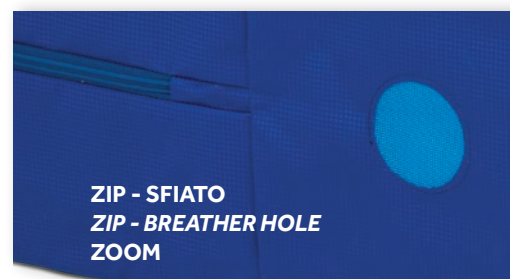

S00604 - S00606

**S00604**

Materasso d. 80, cm 200x100x5

*Mat d. 80, 200x100x5 cm*

**S00606**

Materasso d. 80, cm 200x100x5 fondo antiscivolo

*Mat d. 80, 200x100x5 cm, slip-proof bottom side*

S00608 - S00610

**S00608**

Materasso d. 60, cm 200x100x10

*Mat d. 60, 200x100x10 cm*

**S00610**

Materasso d. 60, cm 200x100x10 fondo antiscivolo

*Mat d. 60, 200x100x10 cm, slip-proof bottom side*



S00612- S00614

**S00612**

Materasso cm 200x100x20  
Soft landing mat 200x100x20 cm

**S00614**

Materasso cm 200x100x20 fondo antiscivolo  
Soft landing mat 200x100x20 cm, slip-proof bottom side

**S00616**

Materasso cm 200x100x30  
Soft landing mat 200x100x30 cm

**S00618**

Materasso cm 200x100x30 fondo antiscivolo  
Soft landing mat 200x100x30 cm, slip-proof bottom side



S00620- S00622

**S00620**

Materasso cm 200x100x40  
Soft landing mat 200x100x40 cm

**S00622**

Materasso cm 200x100x40 fondo antiscivolo  
Soft landing mat 200x100x40 cm, slip-proof bottom side

**S00624**

Materasso cm 200x100x50  
Soft landing mat 200x100x50 cm

**S00626**

Materasso cm 200x100x50 fondo antiscivolo  
Soft landing mat 200x100x50 cm, slip-proof bottom side

**S00628**

Materasso cm 200x200x40  
Soft landing mat 200x200x40 cm

**S00630**

Materasso cm 200x200x40 fondo antiscivolo  
Soft landing mat 200x200x40 cm, slip-proof bottom side

**S00632**

Materasso cm 200x200x45  
Soft landing mat 200x200x45 cm

**S00634**

Materasso cm 200x200x45 fondo antiscivolo  
Soft landing mat 200x200x45 cm, slip-proof bottom side

**S00636**

Materasso cm 200x200x50  
Soft landing mat 200x200x50 cm

**S00638**

Materasso cm 200x200x50 fondo antiscivolo  
Soft landing mat 200x200x50 cm, slip-proof bottom side

**S00640**

Materasso cm 200x300x30  
Soft landing mat 200x300x30 cm

**S00642**

Materasso cm 200x300x30 fondo antiscivolo  
Soft landing mat 200x300x30 cm, slip-proof bottom side

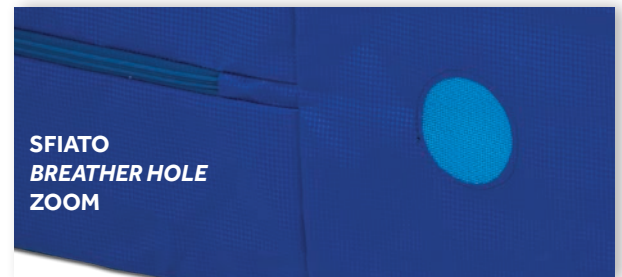
**S00644**

Materasso cm 200x300x40  
Soft landing mat 200x300x40 cm

**S00646**

Materasso cm 200x300x40 fondo antiscivolo  
Soft landing mat 200x300x40 cm, slip-proof bottom side

**S00648**

Materasso cm 200x300x50  
Soft landing mat 200x300x50 cm

**S00650**

Materasso cm 200x300x50 fondo antiscivolo  
Soft landing mat 200x300x50 cm, slip-proof bottom side

**Materassi realizzabili anche con misure diverse da quelle elencate e, a richiesta, rivestimento disponibile anche di colore **giallo**, **verde** e **rosso**.**

**Gym mats can be produced with different dimensions on demand. PVC fabric also available in **yellow**, **green** and **red** colors.**

**NOTE**

S00652 - S00654

**S00652**

Materasso cm 400x200x40, tipo Manoni  
*Manoni type landing mat 400x200x40 cm*

**S00654**

Materasso cm 400x200x40, tipo Manoni, fondo antiscivolo  
*Manoni type landing mat 400x200x40 cm, slip-proof bottom side*

**S00656**

Materasso cm 400x200x45, tipo Manoni  
*Manoni type landing mat 400x200x45 cm*

**S00658**

Materasso cm 400x200x45, tipo Manoni, fondo antiscivolo  
*Manoni type landing mat 400x200x45 cm, slip-proof bottom side*

**S00660**

Materasso cm 400x200x50, tipo Manoni  
*Manoni type landing mat 400x200x50 cm*

**S00662**

Materasso cm 400x200x50, tipo Manoni, fondo antiscivolo  
*Manoni type landing mat 400x200x50 cm, slip-proof bottom side*

**S00664**

Materasso cm 200x200x20 pieghevole a formare un materasso cm 200x100x40  
*Book closing landing mat 200x200x20 cm becoming 200x100x40 cm*

**S00666**

Materasso cm 200x200x20 pieghevole a formare un materasso cm 200x100x40, fondo antiscivolo  
*Book closing landing mat 200x200x20 cm becoming 200x100x40 cm, slip-proof bottom side*



S00652 - S00654 ZOOM

**S00668**

Materasso cm 400x200x20 pieghevole a formare un materasso cm 200x200x40  
*Book closing landing mat 400x200x20 cm becoming 200x200x40 cm*

**S00670**

Materasso cm 400x200x20 pieghevole a formare un materasso cm 200x200x40, fondo antiscivolo  
*Book closing landing mat 400x200x20 cm becoming 200x200x40 cm, slip-proof bottom side*

S00668 - S00670



S00668 - S00670

**S00672**

Fodera di ricambio per materassi dotata di sfiati, maniglie e zip

*Spare cover for mats equipped with breather holes, handles and zip*

**S00674**

Fodera di ricambio per materassi dotata di sfiati, maniglie e zip, con fondo antiscivolo

*Spare cover for mats equipped with breather holes, handles and zip, slip-proof bottom side*

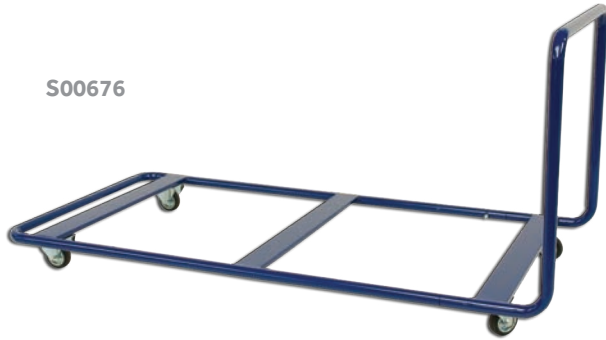
**S00676****S00676**

Carrello porta materassi in acciaio verniciato, cm 200x100, mobile su ruote

*Varnished steel mat trolley, 200x100 cm, mobile on wheels*

**S00678**

Carrello verticale porta materassi in acciaio verniciato, mobile su ruote

*Vertical mat trolley made in varnished steel, mobile on wheels*

**S00678****S00680****S00680**

Tappeto GYM MAT in polietilene a cellula chiusa, fondo antiscivolo, cm 200x100x3

*Gym Mat 200x100x3 cm, high density polyethylene, slip-proof bottom side*

**S00681**

Tappeto GYM MAT in polietilene a cellula chiusa, fondo antiscivolo, cm 200x100x4

*Gym Mat 200x100x4 cm, high density polyethylene, slip-proof bottom side*

**S00682****S00682**

Tappeto GYM MAT in polietilene a cellula chiusa, fondo antiscivolo, cm 200x100x5

*Gym Mat 200x100x5 cm, high density polyethylene, slip-proof bottom side*

**S00683**

Tappeto GYM MAT in polietilene a cellula chiusa, fondo antiscivolo, cm 200x100x6

*Gym Mat 200x100x6 cm, high density polyethylene, slip-proof bottom side*

**S00684**

Tappeto MAT GOLD K14, in poliuretano, cm 200x100x3

*Mat Gold K14 polyurethane mat 200x100x3 cm*

**S00685**

Tappeto MAT GOLD K16, in poliuretano, cm 200x100x4

*Mat Gold K16 polyurethane mat 200x100x4 cm*

**S00686**

Tappeto MAT GOLD K20, in poliuretano, cm 200x100x5

*Mat Gold K20 polyurethane mat 200x100x5 cm*

**S00687**

Tappeto MAT GOLD K24, in poliuretano, cm 200x100x6

*Mat Gold K24 polyurethane mat 200x100x6 cm*





S00688

**S00688****NEW**

Tappeto per karate ad incastro omologato WKF, in polietilene cm 100x100x2

*Polyethylene WKF approved karate mat 100x100x2 cm, attachable on the 4 sides*

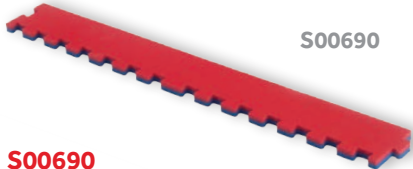

S00690

**S00690**

Bordo tappeto karate in polietilene, elemento da cm 100

*Polyethylene lateral element for karate area, length 100 cm*

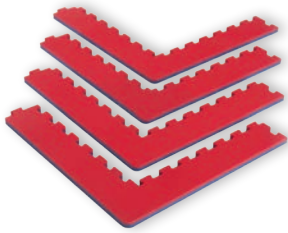
**S00692**

Kit angoli tappeto karate, in polietilene  
*Set of polyethylene corner elements for karate area*



S00694

**S00694****NEW**

Tatami per judo ad incastro in polietilene, cm 100x100x4

*Polyethylene tatami judo mat, 100x100x4 cm, attachable on the 4 sides*

**S00696**

Bordo tatami judo in polietilene, elemento da cm 100

*Polyethylene lateral element for judo area, length 100 cm*

**S00698**

Kit angoli tappeto judo in polietilene  
*Set of polyethylene corner elements for judo area*

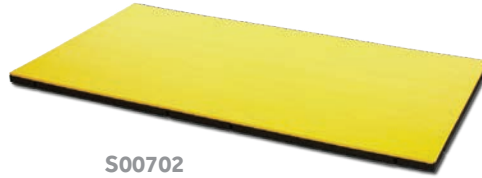

S00702

**S00702****NEW**

Tatami per judo in polietilene, cm 200x100x5, omologato IJF, con sistema di aggancio a scomparsa

*Polyethylene tatami judo mat, 200x100x5 cm, IJF approved, with hidden attaching solution*



S00704 - S00706 - S00708

**S00704**

Tappeto lotta in agglomerato d. 150, cm 200x100x5, omologato FILA  
*Wrestling mat d. 150, 200x100x5 cm, FILA approved*

**S00706**

Tappeto lotta in agglomerato d. 150, cm 200x100x5, fondo antiscivolo, omologato FILA  
*Wrestling mat d. 150, 200x100x5 cm, slip-proof base, FILA approved*

**S00708**

Telo di copertura per tappeto lotta, mt 12x12  
*Mat cover for wrestling area, dimensions 12x12 mt*



S00710

**S00710**

Stuoia pieghevole gofrata cm 180x50x0,8 in polietilene  
*Polyethylene folding mat for fitness exercises, 180x50x0.8 cm*



S00712

**S00712**

Stuoia arrotolabile colorata, cm 150x70x1, fondo antiscivolo  
*Coloured rollable mat for fitness exercises 150x70x1 cm, slip-proof bottom side*



S00714

**S00714**

Materassina individuale pieghevole rivestita di vinile, cm 150x60x1  
*Individual folding exercise mat, covered with vinyl material, 150x60x1 cm*

**S00716**

Materassina individuale pieghevole rivestita di vinile, cm 180x60x4  
*Individual folding exercise mat, covered with vinyl material, 180x60x4 cm*



S00718

**S00718**

Materasso jump test per attività di coordinazione al salto  
*Jump test mat for school jump practice*

**S00752**

Palco di salita 2 pertiche di acciaio, 2 funi di canapa, 2 scale a corda, altezza mt 5  
*Climbing apparatus 2 steel poles, 2 hemp ropes, 2 rope ladders, height 5 mt*

**S00754**

Palco di salita 2 pertiche di acciaio, 2 funi di canapa, 2 scale a corda, altezza mt 6  
*Climbing apparatus 2 steel poles, 2 hemp ropes, 2 rope ladders, height 6 mt*

**S00756**

Palco di salita 2 pertiche di acciaio, 2 funi di canapa, altezza mt 5  
*Climbing apparatus 2 steel poles, 2 hemp ropes, height 5 mt*

**S00758**

Palco di salita 2 pertiche di acciaio, 2 funi di canapa, altezza mt 6  
*Climbing apparatus 2 steel poles, 2 hemp ropes, height 6 mt*

**S00760**

Palco di salita 2 pertiche di legno, 2 funi di canapa, altezza mt 5  
*Climbing apparatus 2 wooden poles, 2 hemp ropes, height 5 mt*

**S00762**

Palco di salita 2 pertiche di legno, 2 funi di canapa, altezza mt 6  
*Climbing apparatus 2 wooden poles, 2 hemp ropes, height 6 mt*

**S00764**

Palco di salita 3 pertiche di acciaio, 3 funi di canapa, altezza mt 5  
*Climbing apparatus 3 steel poles, 3 hemp ropes, height 5 mt*

**S00766**

Palco di salita 3 pertiche di acciaio, 3 funi di canapa, altezza mt 6  
*Climbing apparatus 3 steel poles, 3 hemp ropes, height 6 mt*

**S00768**

Palco di salita 3 pertiche di legno, 3 funi di canapa, altezza mt 5  
*Climbing apparatus 3 wooden poles, 3 hemp ropes, height 5 mt*

**S00770**

Palco di salita 3 pertiche di legno, 3 funi di canapa, altezza mt 6  
*Climbing apparatus 3 wooden poles, 3 hemp ropes, height 6 mt*

**S00772**

Fune per salita, lunghezza mt 5  
*Climbing hemp rope, length 5 mt*

**S00774**

Fune per salita, lunghezza mt 6  
*Climbing hemp rope, length 6 mt*

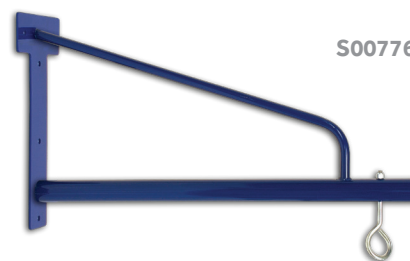
**S00776**

Mensola per fune completa di gancio per attacco  
*Varnished steel wall rack for climbing rope*

**Funi, pertiche e scale a corda possono essere fissate a muro tramite sistema di sospensione S00792.**

***Climbing ropes, poles and rope ladders can be installed to the wall through apparatus S00792.***

**NOTE**

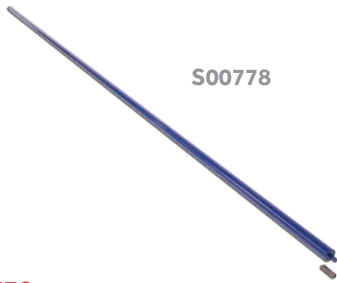

S00778

**S00778**

Pertica di acciaio, altezza mt 5  
Varnished tubular steel climbing pole 5 mt long



S00780 - ZOOM

**S00780**

Pertica di acciaio, altezza mt 6  
Varnished tubular steel climbing pole 6 mt long



S00782

**S00782**

Pertica di legno, altezza mt 5  
Wooden climbing pole 5 mt long



S00784 - ZOOM

**S00784**

Pertica di legno, altezza mt 6  
Wooden climbing pole 6 mt long



ZOOM

S00786

**S00786**

Mensola per pertica completa di gancio per attacco  
Varnished steel wall rack for climbing pole



S00788

**S00788**

Scala a corda di canapa con pioli di faggio, lunghezza mt 5  
Hemp rope ladder, 5 mt long with solid wooden rungs

**S00790**

Scala a corda di canapa con pioli di faggio, lunghezza mt 6  
Hemp rope ladder, 6 mt long with solid wooden rungs



ZOOM

S00792

**S00792**

Sistema di sospensione e accostamento a parete per attrezzi da arrampicata, struttura variabile in base al numero di funi, pertiche o scale supportate  
Apparatus for supporting and sliding to the wall climbing equipment, to be dimensioned depending on the number of climbing ropes, poles or ladders connected



S00796

**S00796**

Sistema di arrampicata da fissare a muro composto di nr 12 pannelli di legno con appigli in resina su telaio in acciaio  
Practice climbing area made of 12 wooden panels with resin handholds mounted onto steel frame to be fixed to the wall



**Sistema di arrampicata S00796 disponibile, su richiesta, anche in versione per uso esterno.**

**Practice climbing area S00796 available, on demand, on outdoor use version.**

**NOTE**

**Palle mediche, palle mediche attrezzate - Medicine balls, medicine balls with rope**
**S00852**

Palla medica rigonfiabile di gomma, peso kg 1  
*Rubber medicine ball with needle valve, weight 1 kg*

**S00854**

Palla medica rigonfiabile di gomma, peso kg 1,5  
*Rubber medicine ball with needle valve, weight 1.5 kg*

**S00856**

Palla medica rigonfiabile di gomma, peso kg 2  
*Rubber medicine ball with needle valve, weight 2 kg*

**S00858**

Palla medica rigonfiabile di gomma, peso kg 3  
*Rubber medicine ball with needle valve, weight 3 kg*

**S00860**

Palla medica rigonfiabile di gomma, peso kg 4  
*Rubber medicine ball with needle valve, weight 4 kg*

**S00862**

Palla medica rigonfiabile di gomma, peso kg 5  
*Rubber medicine ball with needle valve, weight 5 kg*

**S00864**

Palla medica rigonfiabile di gomma, peso kg 6  
*Rubber medicine ball with needle valve, weight 6 kg*

**S00866**

Palla medica rigonfiabile di gomma, peso kg 7  
*Rubber medicine ball with needle valve, weight 7 kg*

**S00868**

Palla medica rigonfiabile di gomma, attrezzata, peso kg 1  
*Rubber medicine ball with needle valve and rope, weight 1 kg*

**S00870**

Palla medica rigonfiabile di gomma, attrezzata, peso kg 1,5  
*Rubber medicine ball with needle valve and rope, weight 1.5 kg*

**S00872**

Palla medica rigonfiabile di gomma, attrezzata, peso kg 2  
*Rubber medicine ball with needle valve and rope, weight 2 kg*

**S00874**

Palla medica rigonfiabile di gomma, attrezzata, peso kg 3  
*Rubber medicine ball with needle valve and rope, weight 3 kg*

**S00876**

Palla medica rigonfiabile di gomma, attrezzata, peso kg 4  
*Rubber medicine ball with needle valve and rope, weight 4 kg*

**S00878**

Palla medica rigonfiabile di gomma, attrezzata, peso kg 5  
*Rubber medicine ball with needle valve and rope, weight 5 kg*

**S00880**

Palla medica rigonfiabile di gomma, attrezzata, peso kg 6  
*Rubber medicine ball with needle valve and rope, weight 6 kg*

**S00882**

Palla medica rigonfiabile di gomma, attrezzata, peso kg 7  
*Rubber medicine ball with needle valve and rope, weight 7 kg*

## Panche, panche svedesi - Gym benches

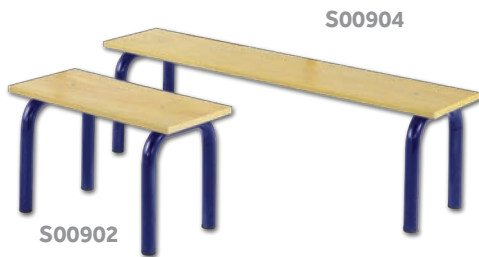
**S00902**

Panca per esercizi alla spalliera, piano in legno, lunghezza cm 60

*Bench suitable for wall bar exercises, wooden surface, length 60 cm*

**S00904**

Panca per esercizi alla spalliera, piano in legno, lunghezza cm 120

*Bench suitable for wall bar exercises, wooden surface, length 120 cm*

**S00906**

Panca per addominali agganciabile alla spalliera, piano in legno

*Incline board for abdominal exercises on wall bar, wooden surface*

**S00908**

Panca per addominali agganciabile alla spalliera, piano imbottito e rivestito

*Incline board for abdominal exercises on wall bar, padded and covered surface*

**S00914**

Panca svedese con telaio in acciaio e asse di equilibrio in legno, lunghezza mt 3

*Swedish gym bench with steel structure and wooden balance beam, 3 mt long*

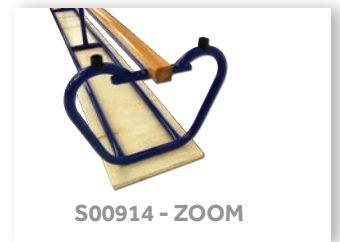

S00914 - ZOOM

**S00916**

Panca svedese con telaio in acciaio senza asse di equilibrio, lunghezza mt 3

*Swedish gym bench with steel structure without balance beam, 3 mt long*

**S00918 - S00920****S00918**

Panca svedese interamente di legno massiccio, lunghezza mt 2

*Swedish gym bench entirely made of wood, 2 mt long*

S00918  
S00920  
ZOOM**S00920**

Panca svedese interamente di legno massiccio, lunghezza mt 3,5

*Swedish gym bench entirely made of wood, 3.5 mt long*

**NOTE**

Panca svedese **S00920** realizzabile anche con lunghezze diverse.

*Swedish gym bench **S00920** can be produced with different length.*

## Plinti - Vaulting boxes

**S00952**

Plinto con gambe di acciaio regolabili in altezza, piano imbottito e rivestito di cuoio naturale

*Gymnastic vaulting table, steel adjustable legs, wooden surface padded and covered with natural leather*



S00954

**S00954**

Plinto con gambe di acciaio regolabili in altezza, piano imbottito e rivestito di cuoio sintetico

*Gymnastic vaulting table, steel adjustable legs, wooden surface padded and covered with synthetic leather*

**S00956**

Plinto trapezoidale di legno a 6 cassoni, piano imbottito e rivestito di cuoio naturale

*Trapezoidal wooden vaulting box with 6 sections, padded and natural leather covered surface*



S00958

**S00958**

Plinto trapezoidale di legno a 6 cassoni, piano imbottito e rivestito di cuoio sintetico

*Trapezoidal wooden vaulting box with 6 sections, padded and synthetic leather covered surface*

**S00960**

Plinto verticale di legno a 5 cassoni con dispositivo di trasporto su ruote, piano imbottito e rivestito di cuoio sintetico

*Vertical wooden vaulting box with 5 sections, padded and synthetic leather covered surface, transport device on wheels included*



S00962

**S00962**

Plinto verticale di legno a 6 cassoni con dispositivo di trasporto su ruote, piano imbottito e rivestito di cuoio sintetico

*Vertical wooden vaulting box with 6 sections, padded and synthetic leather covered surface, transport device on wheels included*

## Quadri svedesi - Swedish runged wall bars



S01004

**S01002**

Quadro svedese oscillante a 16 fori (4X4 h), incluse mensole a muro  
*Swedish runged swinging wall bar with 16 holes (4X4 h), included wall racks*

**S01004**

Quadro svedese oscillante a 24 fori (4X6 h), incluse mensole a muro  
*Swedish runged swinging wall bar with 24 holes (4X6 h), included wall racks*

**S01006**

Quadro svedese oscillante a 36 fori (6X6 h), incluse mensole a muro  
*Swedish runged swinging wall bar with 36 holes (6X6 h), included wall racks*

19

## Scale Wall ladders

**S01052**

Scala ortopedica dritta da fissare a parete, montanti di acciaio e pioli di faggio

*Wall mounted straight ladder, steel columns and wooden rungs*

**S01054**

Scala ortopedica curva da fissare a parete, montanti di acciaio e pioli di faggio

*Wall mounted curved ladder, steel columns and wooden rungs*

**S01056**

Scala ortopedica dritta da fissare a parete, montanti e pioli di faggio

*Wall mounted straight ladder, entirely made in wood*

**S01058**

Scala ortopedica curva da fissare a parete, montanti e pioli di faggio

*Wall mounted curved ladder, entirely made in wood*

**S01060**

Scala orizzontale da fissare a parete, lunghezza mt 5, graduabile in altezza

*Wall mounted wooden horizontal ladder on steel frame, adjustable height, length 5 mt*

**S01062**

Scala orizzontale trasportabile, lunghezza mt 5, graduabile in altezza

*Transportable wooden horizontal ladder on steel supports, adjustable height, length 5 mt*

20

## Spalliere e articoli in legno - Wall bars and wooden equipment

**S01102**

Spalliera svedese di legno a 1 campata, cm 90x250

*Swedish wooden wall bar at 1 span, 90x250 cm*

**S01104**

Spalliera svedese di legno a 2 campate, cm 180x250

*Swedish wooden wall bar at 2 spans, 180x250 cm*

**S01106**

Spalliera svedese di legno a 1 campata, cm 90x250, modello smontato

*Swedish wooden wall bar at 1 span, 90x250 cm, dismantled model*

**S01108**

Spalliera svedese di legno a 2 campate, cm 180x250, modello smontato

*Swedish wooden wall bar at 2 spans, 180x250 cm, dismantled model*

**S01110**

Spalliera svedese di legno a 1 campata a norme DIN, cm 90x260

*Swedish wooden wall bar at 1 span in accordance to DIN norm, 90x260 cm*

**S01112**

Spalliera svedese di legno a 2 campate a norme DIN, cm 180x260

*Swedish wooden wall bar at 2 spans, in accordance to DIN norm, 180x260 cm*

**S01114**

Poggiaschiena curvo, imbottito e rivestito, agganciabile alla spalliera

*Curved padded and covered backrest to be attached to wall bar*

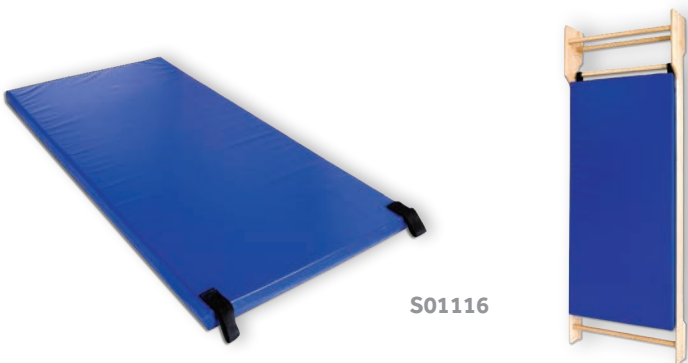
**S01116**

Materasso per spalliera cm 180x85 con bandelle di Velcro

*Wall bar soft mat 180x85 cm with Velcro strips*

**S01118**

Piolo di ricambio per spalliera, lunghezza cm 90

*Spare wooden rung for wall bar, length 90 cm*

**S01120**

Piolo di ricambio per spalliera, lunghezza cm 180

*Spare wooden rung for wall bar, length 180 cm*



S01130

**S01130**

Scivolo in legno per spalliera, larghezza cm 45, lunghezza cm 240

*Wooden slide hanging on wall bar, width 45 cm, length 240 cm*

S01132

**S01132**

Scaletta zig-zag in legno per spalliera, larghezza cm 35, lunghezza cm 250

*Wooden zigzag ladder hanging on wall bar, width 35 cm, length 250 cm*

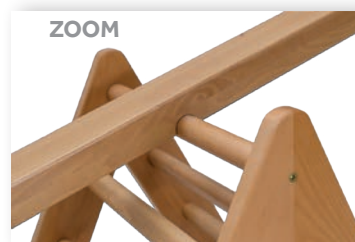

ZOOM

S01134

**S01134**

Asse di equilibrio in legno con scaletta triangolare, larghezza cm 10, lunghezza cm 250. Agganciabile anche a spalliera

*Wooden balancing beam on triangle step module, width 10 cm, length 250 cm. Can be connected to wall bar*





ZOOM

S01136

**S01136**  
Panchetta di equilibrio in legno con scaletta triangolare, larghezza cm 18, lunghezza cm 250. Agganciabile anche a spalliera  
*Wooden balancing bench on triangle step module, width 18 cm, length 250 cm. Can be connected to wall bar*



S01142

**S01142**  
Set di 5 sgabelli in legno con dimensioni differenti per esercizi ginnici e fitness  
*Set of 5 wooden gymnastic and fitness stools in different sizes*

**S01138**  
Scaletta "gallina" in legno per spalliera, larghezza cm 18, lunghezza cm 250  
*Wooden hen bench hanging on wall bar, width 18 cm, length 250 cm*



S01138



S01144

**S01144**  
Scaletta semicircolare in legno bassa, dimensioni cm 90x60x30  
*Small semi-circular wooden ladder, dimensions 90x60x30 cm*



S01140

**S01140**  
Set di 10 panchette in legno con lunghezze differenti per esercizi ginnici e fitness  
*Set of 10 wooden small gymnastic and fitness benches in different lengths*



S01146

**S01146**  
Scaletta semicircolare in legno alta, dimensioni cm 100x60x50  
*Large semi-circular wooden ladder, dimensions 100x60x50 cm*



S01144 + S01146

S01148

**S01148**

Percorso di equilibrio in legno, componibile attraverso 5 supporti e 5 assi  
*Modular wooden balance path composed of 5 blocks and 5 axes*

21

## Trampolini - Trampolines



S01152

**S01152**

Mini trampolino, diametro cm 90, altezza cm 20  
*Mini trampoline, round shape diameter 90 cm, height 20 cm*



S01154

**S01154**

Trampolino elastico con struttura ad altezza ed inclinazione regolabili, in acciaio verniciato, dimensioni cm 125x125, completo di protezione laterale  
*Elastic trampoline made of varnished steel structure with adjustable height and inclination, dimensions 125x125 cm, including side protection pad*

S01156

**S01156**

Protezione laterale per trampolino S01154  
*Side protection pad for trampoline S01154*



S01158

**S01158**

Trampolino elastico Master School per allenamento ed attività scolastica, area di salto cm 366x183, telo in poliestere  
*Master School elastic trampoline for practice, polyester jumping bed 366x183 cm*



S01160

**S01160**

Trampolino Ultimate omologato FIG per competizioni, area di salto cm 426x213, telo in nylon  
*Ultimate trampoline, FIG approved for competition, nylon jumping bed 426x213 cm*

22

Palle e accessori per ginnastica ritmica - *Balls and accessories for rhythmic gymnastic*

S01202

**S01202**

Palla per ginnastica ritmica di gomma, peso gr 280  
*Rubber rhythmic gymnastic ball, weight 280 gr*

**S01204**

Palla per ginnastica ritmica di gomma, peso gr 400  
*Rubber rhythmic gymnastic ball, weight 400 gr*



S01206

**S01206**

Palla per ginnastica ritmica in materiale silicico, peso gr 400, omologata FIG  
*Rubber rhythmic gymnastic ball made in silicone-base compound, weight 400 gr, FIG approved*



S01208

**S01208**

Palla per ginnastica ritmica di caucciù naturale Sasaki, omologata FIG per competizioni, monocoloro  
*Natural rubber rhythmic gymnastic ball Sasaki, FIG approved for competitions, monochrome*

S01210

**S01210**

Nastro per ginnastica ritmica, lunghezza mt 6  
*Coloured rhythmic gymnastic ribbon, length 6 mt*



S01212

**S01212**

Avvolgitore nastro per ginnastica ritmica  
*Plastic device for wrapping up the rhythmic gymnastic ribbon*



S01214

**S01214**

Nastro per ginnastica ritmica Sasaki, con bastoncino, omologato FIG per competizioni  
*Coloured rhythmic gymnastic ribbon Sasaki, complete of stick, FIG approved for competitions*



S01216

**S01216**

Funicella di cotone colorato, piombata, per ginnastica ritmica  
*Coloured rhythmic gymnastic center leaded cotton rope*



S01218

**S01218**

Funicella per ginnastica ritmica Sasaki, in poliestere, omologata FIG per competizioni  
*Coloured rhythmic gymnastic rope Sasaki, made of polyester, FIG approved for competitions*

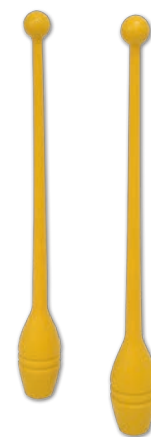
**S01220**

Coppia clavette di nylon per ginnastica ritmica secondo norme FIG  
*Pair of coloured rhythmic gymnastic nylon clubs in accordance to FIG norms*

Palle **S01208** disponibili in varie combinazioni cromatiche, per informazioni: [info@sportsystem.it](mailto:info@sportsystem.it)

**NOTE**

**Balls S01208** available in different chromatic combinations, for more info: [info@sportsystem.it](mailto:info@sportsystem.it)





S01222

**S01222**

Coppia clavette di plastica per ginnastica ritmica Sasaki, omologate FIG per competizioni

*Pair of coloured rhythmic gymnastic plastic clubs Sasaki, FIG approved for competitions*



S01224

**S01224**

Cerchio di PVC colorato, diametro cm 80 per allenamento ginnastica ritmica  
*Coloured plastic tubular hoop, diameter 80 cm for practicing rhythmic gymnastic*

**S01226**

Cerchio di PVC colorato, diametro cm 90 per allenamento ginnastica ritmica  
*Coloured plastic tubular hoop, diameter 90 cm for practicing rhythmic gymnastic*

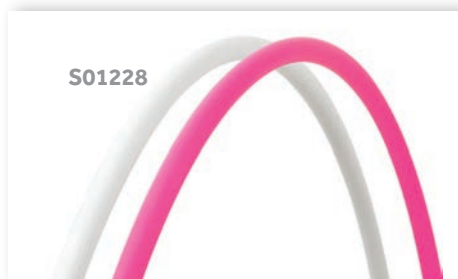

S01228

**S01228**

Cerchio di PVC colorato per ginnastica ritmica Sasaki, omologato FIG per competizioni, diametro cm 85  
*Coloured rhythmic gymnastic plastic tubular hoop Sasaki, FIG approved for competitions, diameter 85 cm*



23

**Accessori per ginnastica aerobica**  
**Accessories for aerobic gymnastic**



S01302

**S01302**

Bande elastiche colorate per aerobica  
*Aerobic coloured elastic band*



S01306

**S01306**

Elastico tubing per esercizi di potenziamento, resistenza media  
*Elastic tubing, medium resistance*



S01310

**S01310**

Bastone di plastica, diametro mm 25, lunghezza cm 120  
*Plastic gymnastic stick, diameter 25 mm, length 120 cm*

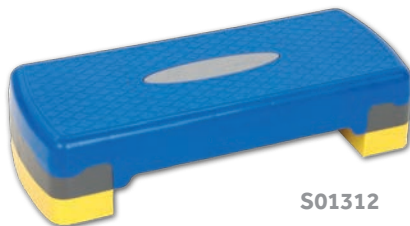

S01312

**S01312**

Step in plastica componibile ad altezza variabile  
*Plastic step with adjustable height*

S01314

**S01314**

Mini trampolino, diametro cm 90, altezza cm 20

*Mini trampoline, round shape diameter 90 cm, height 20 cm*



24

**Accessori per ginnastica propriocettiva**  
**Accessories for rehabilitation gymnastic**



S01402

**S01402**

Pedana oscillante di legno cm 80x60x13  
*Wooden balancing board, dimensions 80x60x13 cm*



S01404

**S01404**

Pedana oscillante di legno cm 170x60x13  
*Wooden balancing board, dimensions 170x60x13 cm*

S01406

**S01406**

Dondolo Bobath di legno, diametro cm 80, altezza cm 10  
*Wooden Bobath balancing board, round surface, diameter 80 cm, height 10 cm*

S01412

**S01412**

Semisfera Medusa con antiscivolo  
*Medusa inflatable balancing ball*

S01424

**S01424**

Materassina individuale pieghevole rivestita di vinile, cm 180x60x4  
*Individual folding exercise mat, covered with vinyl material, 180x60x4 cm*

S01408

**S01408**

Temix attrezzo per ginnastica propriocettiva e riabilitazione  
*Temix step device for training and rehabilitation therapy*

S01426

**S01426**

Stuoia Yoga arrotolabile in PVC, dimensioni cm 168x61x0,3  
*Yoga rollable mat made of PVC, dimensions 168x61x0.3 cm*

25

**Accessori per  
 Yoga e Pilates  
 Accessories for  
 Yoga and Pilates**

S01420

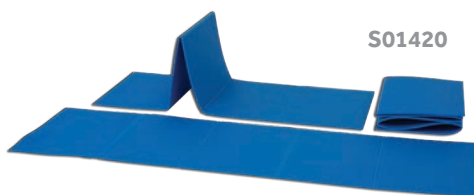
**S01420**

Stuoia pieghevole gofrata cm 180x50x0,8 in polietilene  
*Polyethylene folding mat 180x50x0.8 cm*

S01428

**S01428**

Mattone Yoga in EVA, dimensioni cm 20x12x7,5  
*Yoga block made in EVA, dimensions 20x12x7.5 cm*

S01410

**S01410**

Tavoletta Proprio di legno con palla ellittica gonfiabile adatta per la ginnastica riabilitativa  
*Proprio wooden platform for training and rehabilitation therapy*

S01422

**S01422**

Stuoia arrotolabile colorata cm 150x70x1, fondo antiscivolo  
*Coloured rollable mat 150x70x1 cm, slip-proof bottom side*

S01432

**S01432**

Pilates roller ball gonfiabile, diametro cm 15, lunghezza cm 75  
*Pilates roller ball inflatable, diameter 15 cm, length 75 cm*



S01434

**S01434**

Pilates roller foam in gomma espansa, diametro cm 15, lunghezza cm 90  
*Pilates roller foam, diameter 15 cm, length 90 cm*



S01436

**S01436**

Fit Circle, anello elastico con impugnatura  
*Fit Circle elastic ring with handle*



S01438

**S01438**

Pilates Dome, semisfera gonfiabile con elastici e maniglie  
*Pilates Dome inflatable semi-sphere with elastics and handles*

S01440

**S01440**

Cuneo lombare per Pilates, rivestito di tessuto sintetico  
*Half roll for Pilates exercises, covered by synthetic material*

26

## Percorsi ed accessori per attività psicomotorie Equipment for psychomotor activities

**S01453**

Base semisferica per attività psicomotorie, in plastica zavorrabile, sagomata per supportare cerchi e bastoni, diametro cm 20  
*Half-spherical base for psychomotor activities, made of plastic to be filled, shaped in order to support hoops and sticks, diameter 20 cm*



S01453

**S01454**

Cono di materiale plastico, altezza cm 30 con fori  
*Coloured plastic cone height 30 cm with holes*

**S01456**

Cono di materiale plastico, altezza cm 50 con fori  
*Coloured plastic cone height 50 cm with holes*



S01456

**S01458**

Cerchio di nylon colorato, sezione piatta, diametro cm 60  
*Coloured nylon hoop, flat section, diameter 60 cm*

**S01460**

Cerchio di nylon colorato, sezione piatta, diametro cm 70  
*Coloured nylon hoop, flat section, diameter 70 cm*

**S01462**

Bastone di plastica, diametro mm 25, lunghezza cm 120  
*Plastic gymnastic stick, diameter 25 mm, length 120 cm*





S01476

**S01476**

Anello di gomma liscia colorata,  
diametro cm 18  
*Coloured rubber gym ring, diameter  
18 cm*



S01480

**S01480**

Set articoli ed accessori per  
psicomotricità fornito su  
carrello in legno S00366  
*Set of articles and accessories  
for psychomotor activities  
supplied with wooden trolley  
S00366*



S01482

**S01482**

Tamburello completo di baticchio  
*Tambourine with stick*

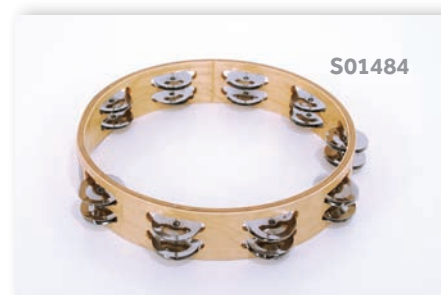

S01484

**S01484**

Cembalo di legno con sonagli  
*Wooden tambourine with metal jingles*

27

**Figure geometriche in gomma - Soft geometric construction elements****NOTE**

Figure geometriche in gomma disponibili,  
su richiesta, anche in altre dimensioni, oltre a  
quelle elencate.

*Soft geometric construction elements available, on  
demand, with sizes different from those listed.*

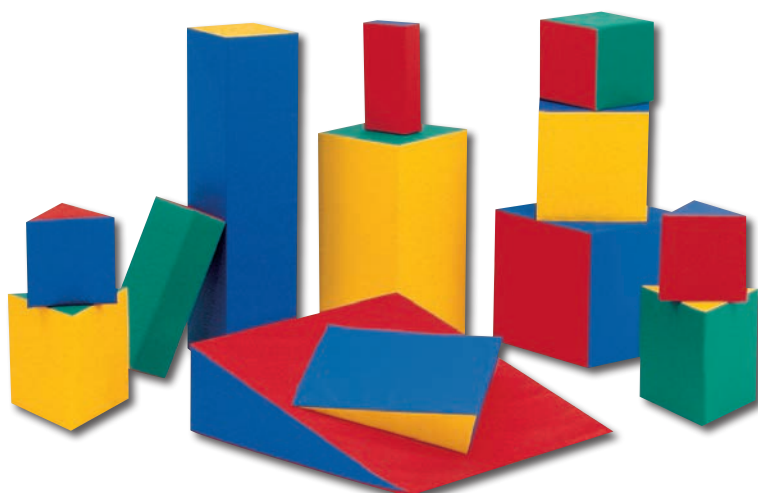
**S01492**

Triangolo, lato cm 30  
*Triangle, side 30 cm*

**S01494**

Cubo cm 30x30x30  
*Cube 30x30x30 cm*

**S01496**

Parallelepipedo cm 60x30x15  
*Block 60x30x15 cm*

**S01498**

Cilindro diametro cm 25, lunghezza cm 100  
*Cylinder diameter 25 cm, length 100 cm*

**S01500**

Cilindro diametro cm 25, lunghezza cm 50  
*Cylinder diameter 25 cm, length 50 cm*

**S01502**

Mezzocilindro diametro cm 25, lunghezza cm 50  
*Half cylinder diameter 25 cm, length 50 cm*

**S01504**

Cuneo cm 100x100x40  
*Wedge-shaped 100x100x40 cm*

S01506

**S01506**

Percorso gioco: scala, ruota, supporto ruota, cuneo, scivolo  
 Construction set made of: step, circle, circle's support, wedge-shaped, slope

S01508

**S01508**

Piscina quadrata con elementi accostabili mediante Velcro (palline escluse), dimensioni cm 200x200x50  
 Ball pool with soft foam walls to be easily attached one to the other (balls not included), dimensions 200x200x50 cm



S01510

**S01510**

Materasso pouf cm 200x200x30, super soffice  
 Pouf mat 200x200x30 cm, extra soft

28

**Palle psicomotricità, air ball, palle con maniglia e varie**  
**Psychomotor balls, air balls, bouncing balls and other balls**

S01520

**S01520**

Palla per psicomotricità, diametro cm 45  
 Psychomotor ball, diameter 45 cm

**S01522**

Palla per psicomotricità, diametro cm 55  
 Psychomotor ball, diameter 55 cm

**S01524**

Palla per psicomotricità, diametro cm 65  
 Psychomotor ball, diameter 65 cm

**S01526**

Palla per psicomotricità, diametro cm 85  
 Psychomotor ball, diameter 85 cm

**S01528**

Palla per psicomotricità, diametro cm 120  
 Psychomotor ball, diameter 120 cm

S01530

**S01530**

Physio Roll per attività psicomotorie, diametro cm 40, lunghezza cm 65  
 Physio Roll for psychomotor activities, diameter 40 cm, length 65 cm



**S01532**

Palla air ball super soft diametro cm 12  
Air ball super soft diameter 12 cm



S01538

**S01538**

Palla in gomma gonfiabile con  
impugnatura, diametro cm 40  
Rubber reinflatable bouncing ball with  
handle, diameter 40 cm



S01544

**S01544**

Pallone sonoro super soffice  
Super soft ball with hidden jingle

**S01546**

Palla di spugna colorata, diametro  
mm 70  
Coloured foam sponge ball, diameter  
70 mm

**S01534**

Palla air ball super soft diametro cm 18  
Air ball super soft diameter 18 cm

**S01540**

Palla in gomma gonfiabile con  
impugnatura, diametro cm 55  
Rubber reinflatable bouncing ball with  
handle, diameter 55 cm



S01548

**S01548**

Palla di spugna colorata, diametro  
mm 200  
Coloured foam sponge ball, diameter  
200 mm

**S01536**

Palla air ball super soft diametro cm 24  
Air ball super soft diameter 24 cm

**S01542**

Palla in gomma gonfiabile con  
impugnatura, diametro cm 65  
Rubber reinflatable bouncing ball with  
handle, diameter 65 cm



S01550

**S01550**

Pallina di gomma bugnata colorata,  
diametro cm 12, peso gr 100  
Easy grip wrinkled rubber ball, diameter  
12 cm, weight 100 gr



Inquadra il QR Code di sinistra col tuo cellulare per accedere  
alla sezione Ginnastica del sito [www.sportsystem.it](http://www.sportsystem.it)

Scan the QR Code at your right with your mobile phone to  
navigate the Gymnastics section at [www.sportsystem.it](http://www.sportsystem.it) site



LINK

Sbarre danza e supporti - *Ballet barres and supports*

S01602

**S01602**

Sbarra per danza di legno verniciato, lunghezza a richiesta fino ad un massimo di mt 4  
*Varnished wooden ballet barre, length at request up to max 4 mt*

**S01604**

Supporto fisso per sbarra danza, di acciaio verniciato da fissare a parete  
*Wall mounted varnished steel support for ballet barre, fixed height*

**S01606**

Supporto regolabile per sbarra danza, di acciaio verniciato da fissare a parete  
*Wall mounted varnished steel support for ballet barre, height adjustable*

**S01608**

Supporto regolabile per sbarra danza, di acciaio verniciato da fissare a pavimento  
*Varnished steel support for ballet barre, to be fixed to the floor, height adjustable*

**NOTE**

Studiamo la soluzione migliore per arredare i vostri spazi con sbarre danza e relativi supporti.

*We find the best solution to equip your ballet room with barres and corresponding supports.*

S01610

**S01610**

Supporto regolabile per sbarra danza, di acciaio verniciato con base maggiorata autoportante, smontabile  
*Varnished steel support for ballet barre, self standing heavy base, height adjustable, can be dismantled*

**Specchi  
Mirrors****S01622**

Specchio in vetro temperato quadrettato con cornice di legno, cm 100x200 h, inclinazione regolabile, mobile su carrello  
*Tempered glass mirror with print-on grid pattern and wooden frame, 100x200 h cm, adjustable inclination, transportable on trolley*

S01622

31

**Bilancieri, manubri, accessori**  
**Barbells, dumbbells, accessories**

S01624

**S01624**

Specchio in vetro temperato quadrettato con cornice di legno, da fissare a parete, cm 100x200 h  
*Tempered glass mirror with print-on pattern and wooden frame, to be fixed to the wall, dimensions 100x200 h cm*

S01626

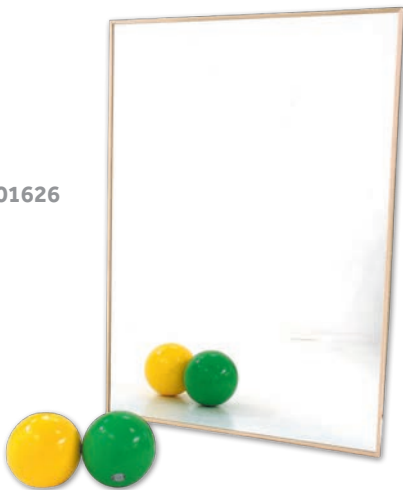
**S01626**

Specchio in vetro temperato liscio con cornice di legno, da fissare a parete, dimensioni a richiesta  
*Tempered glass plain mirror with wooden frame, to be fixed to the wall, dimensions on demand*



S01664



S01654

**S01652**

Bilanciere di acciaio, diametro mm 25, lunghezza cm 150  
*Training barbell bar, diameter 25 mm, length 150 cm*

**S01654**

Bilanciere di acciaio, diametro mm 25, lunghezza cm 180  
*Training barbell bar, diameter 25 mm, length 180 cm*

**S01658**

Bilanciere olimpionico, diametro mm 50, lunghezza cm 150  
*Olympic barbell bar, diameter 50 mm, length 150 cm*

**S01660**

Bilanciere olimpionico, diametro mm 50, lunghezza cm 180  
*Olympic barbell bar, diameter 50 mm, length 180 cm*

**S01662**

Bilanciere olimpionico, diametro mm 50, lunghezza cm 220  
*Olympic barbell bar, diameter 50 mm, length 220 cm*

**S01664**

Bilanciere angolato di acciaio, diametro mm 25, lunghezza cm 145  
*Curl bar, diameter 25 mm, length 145 cm*



S01666

**S01666**

Manubrio di acciaio, diametro mm 25, fisso  
*Dumbbell bar, diameter 25 mm, fixed handle*

S01668

**S01668**

Dischi di ghisa ricoperti di gomma, foro diametro mm 26  
*Weight plates rubber covered, hole diameter 26 mm*

S01670

**S01670**

Dischi olimpionici in ghisa gommata, foro diametro mm 50, impugnatura tri-grip per facilitare la presa  
*Olympic weight plates rubber covered, holed diameter 50 mm, triple grips*

S01674

**S01674**

Manubri di ghisa rivestiti di PVC colorato  
(kg 0,5 - 1 - 2 - 3 - 4 - 5)  
*Pvc covered iron dumbbells  
(0,5 - 1 - 2 - 3 - 4 - 5 kg)*

**S01680**

Paio manubri di plastica colorata kg 3  
*Pair of coloured plastic dumbbells weight  
3 kg*

**S01676**

Paio manubri di plastica colorata kg 1  
*Pair of coloured plastic dumbbells weight  
1 kg*

**S01678**

Paio manubri di plastica colorata kg 2  
*Pair of coloured plastic dumbbells weight  
2 kg*

**S01682**

Paio manubri di plastica colorata kg 4  
*Pair of coloured plastic dumbbells weight  
4 kg*

**S01684**

Paio manubri di plastica colorata kg 5  
*Pair of coloured plastic dumbbells weight  
5 kg*

**S01686**

Manubri fissi con rivestimento in gomma ed impugnatura  
ergonomica antiscivolo, disponibili da kg 2 a kg 40  
*Fixed dumbbell covered in rubber with ergonomic and non-slip  
handle, available from 2 kg to 40 kg*

**S01687**

Kettlebell in ghisa di colore nero opaco per Cross Training.  
Disponibili da kg 8 a 36  
*Kettlebell made of cast iron painted in matt black for Cross  
Training. Available from 8 to 36 kg*

S01688

**S01688**

Rastrelliera porta manubri a 3 ripiani in acciaio verniciato  
*Varnished steel dumbbell rack with 3 shelves*

S01690

**S01690**

Rastrelliera porta manubri, dischi e bilancieri, in acciaio  
verniciato  
*Varnished steel rack supporting dumbbell, weight plates and  
barbell bars*

**Panche per addominali e sollevamento pesi, multifunzione**  
**Abdominal and weightlifting benches, multigym**

S01702

**S01702**

Panca pieghevole imbottita per addominali  
*Padded foldable bench for abdominal exercises*

**S01704**

Panca semplice con supporto per bilanciere e leg extension  
*Practice bench with barbell supports and leg extension*



S01704



S01706

**S01706**

Panca per sollevamento pesi con schienale e sedile ad inclinazione regolabile su struttura in acciaio verniciato  
*Slant bench for weightlifting, backrest and seating element adjustable on varnished steel frame*

S01708

**S01708**

Panca multiuso con supporti per bilanciere, leg extension, arm curl  
*Multipurpose bench with barbell supports, leg extension, arm curl*

**S01710**

Panca multipla, leg extension, pectoral  
*Multi gym machine, leg extension, pectoral*

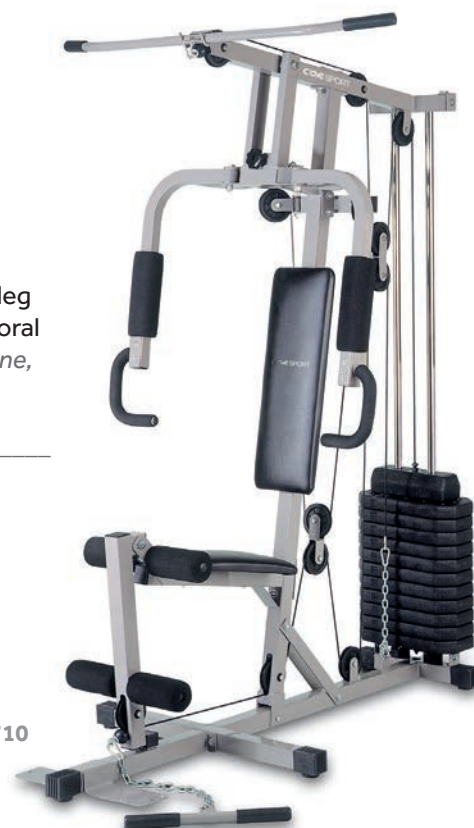

S01710

**S01712**

Coppia supporti per bilanciere regolabili in altezza  
*Pair of height adjustable barbell supports*

33

Accessori potenziamento muscolare - *Accessories for fitness*

S01722

**S01722**

Estensore a 5 molle di acciaio  
*Five springs chest expander*



S01728

**S01728**

Cintura imbottita per sollevamento pesi  
*Padded belt for weightlifting*



S01730

**S01730**

Paia polsiere zavorrate a pesi estraibili,  
kg 2,7  
*Pair of dead weight wrist bands,  
adjustable weight, 2.7 kg*



S01732

**S01732**

Paia cavigliere zavorrate a pesi  
estraibili, kg 4,5  
*Pair of dead weight ankle bands,  
adjustable weight, 4.5 kg*

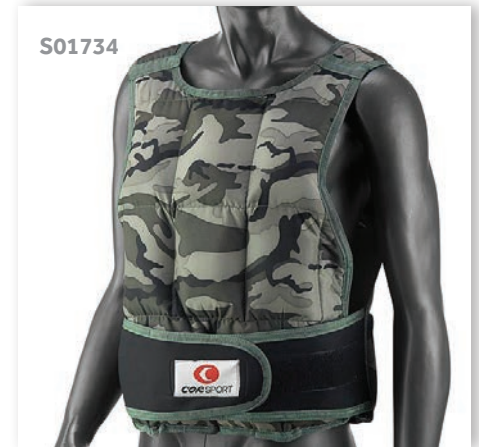

S01734

**S01734**

Giubbino zavorrato, peso graduabile  
fino a kg 10  
*Dead weight vest, adjustable weight up  
to 10 kg*

34

Articoli per boxe - *Boxing equipment*

S01762

**S01762**

Sacco boxe rivestito  
PVC, kg 40  
*Punching bag covered  
with PVC, 40 kg*



S01766

**S01766**

Sacco boxe rivestito  
PVC con fascia di  
cuoio, kg 40  
*Punching bag covered  
with PVC, leather  
central strip, 40 kg*



S01770

**S01770**

Sacco boxe rivestito  
di similpelle, kg 40  
*Punching bag  
synthetic leather  
covered, 40 kg*

**S01764**

Sacco boxe rivestito PVC, kg 50  
*Punching bag covered with PVC, 50 kg*

**S01768**

Sacco boxe rivestito PVC con fascia di  
cuoio, kg 50  
*Punching bag covered with PVC, leather  
central strip, 50 kg*

**S01772**

Sacco boxe rivestito di similpelle, kg 50  
*Punching bag synthetic leather covered,  
50 kg*



S01774

**S01774**

Mensola per sacco boxe da fissare a parete

Varnished steel rack for punching bag to be fixed to the wall

S01776

**S01776**

Estensore per sacco boxe

Expanding chain for punching bag



S01778

**S01778**

Sacco boxe con base riempibile, altezza regolabile

Punching bag with standing base to be filled, adjustable height



S01780

**S01780**

Punching ball su base in vinile, regolabile in altezza

Flexible punching ball with standing vinyl base, adjustable in height



S01782

**S01782**

Piattaforma per punching ball, completa di pera

Wall platform for punching ball, including speed ball



S01784

**S01784**

Caschetto boxe in pelle sintetica (M-L)

Synthetic leather boxing helmet (M-L)



S01786

**S01786**

Corpetto paracolpi reversibile, colore blu o rosso (JR-SR)

Double face chest protector, red or blue color (JR-SR)



S01788

**S01788**

Paio guanti boxe pelle sintetica (8-10-12 once)

Pair boxing gloves synthetic leather (8-10-12 once)



S01790

**S01790**

Ring boxe regolamentare con misura interno corde cm 550x550 su struttura in acciaio verniciato. Completo di colonne imbottite, corde, 2 scalette, tatami in gomma e copertura laterale in PVC

Regular size boxing ring 550x550 cm between ropes on varnished steel structure. Complete of padded columns, ropes, 2 entry ladders, mat surface and side covers in PVC





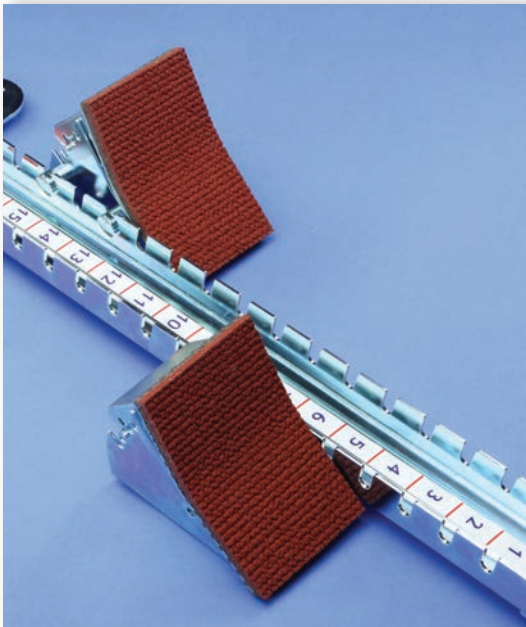

## ATLETICA

La presente categoria è strutturata in una serie ordinata di sottocategorie, ciascuna delle quali dedicata ad una specifica disciplina dell'atletica e ciascuna comprendente sia **attrezzature ed articoli destinati all'allenamento** sia **alternative omologate WA per competizioni**.

Iniziando dalle **discipline su pista** la categoria prosegue quindi con i titoli dedicati alle **discipline da lancio** per finire con le **specialità del salto**.



## ATHLETICS

*This category consists of several different groups of equipment and accessories each one dedicated to a different athletics' discipline and consisting both of **training solutions** as well as **WA approved alternatives**.*

*Starting from **track's disciplines** the category continues with **throwing events' equipment and accessories** and ends with products for **jumping events**.*



1

## Blocchi di partenza, testimoni Starting blocks, relay batons

S02002



### S02002

Paia blocchi di partenza in gomma per palestra  
Pair of rubber starting blocks for indoor use

S02004



### S02004

Blocco di partenza da allenamento in acciaio zincato  
Practice starting blocks made of galvanized steel

S02006



### S02006

Blocco di partenza in acciaio zincato omologato WA per competizioni  
Galvanized steel starting blocks WA approved for competition

S02008

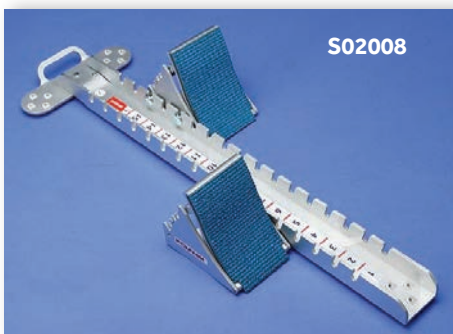

### S02008

Blocco di partenza in alluminio omologato WA per competizioni  
Aluminium starting blocks WA approved for competition

S02010



### S02010

Testimone staffetta di plastica  
Plastic relay baton

S02012



### S02012

Testimone staffetta di alluminio per allenamento  
Aluminium practice relay baton

S02014



### S02014

Testimone staffetta di alluminio omologato WA per competizioni  
Aluminium relay baton WA approved for competition

2

## Ostacoli Hurdles

S02052



### S02052

Set ostacoli Over, 10 pezzi ad altezze differenti  
Set of 10 practice Over hurdles with different heights

S02054

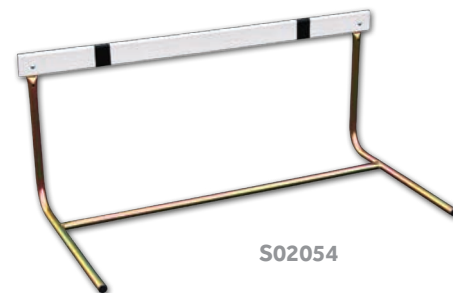

### S02054

Ostacolo in acciaio per allenamento, altezza fissa cm 50  
Steel practice hurdle, fixed height 50 cm

S02056

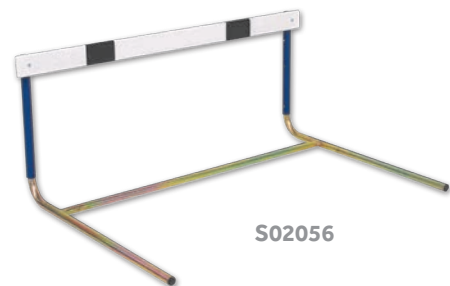

### S02056

Ostacolo in acciaio per allenamento, altezza regolabile cm 50/60/76,2  
Steel practice hurdle, adjustable height 50/60/76.2 cm



**S02058**  
Ostacolo in acciaio per allenamento, antinfortunistico con ritorno a molla, altezza regolabile cm 50/60/76,2  
*Steel practice hurdle, safety pendular model with tension spring, adjustable height 50/60/76.2 cm*



**S02070**  
Ostacolo olimpionico in acciaio ed alluminio, altezza regolabile cm 76,2/84/91,4/100/106,7 omologato WA per competizioni  
*Olympic hurdle made of steel and aluminium, adjustable height 76.2/84/91.4/100/106.7 cm WA approved for competition*



**S02076**  
Carrello porta ostacoli in acciaio zincato, mobile su ruote  
*Galvanized steel trolley for hurdles, mobile on wheels*



**S02060**  
Ostacolo in acciaio per allenamento, altezza regolabile cm 76,2/84/91,4  
*Steel practice hurdle, adjustable height 76.2/84/91.4 cm*



**S02072**  
Ostacolo olimpionico in alluminio, altezza regolabile cm 76,2/84/91,4/100/106,7 omologato WA per competizioni  
*Olympic hurdle made of aluminium, adjustable height 76.2/84/91.4/100/106.7 cm WA approved for competition*



**S02078**  
Ostacolo per riviera corsa siepi in acciaio zincato, trave di legno lunghezza cm 366, regolabile in altezza  
*Water jump steeplechase hurdle, galvanized steel structure, wooden bar 366 cm long, adjustable height*

**S02064**  
Ostacolo in acciaio con altezza regolabile cm 76,2/84/91,4/100/106,7  
*Steel professional hurdle, adjustable height 76.2/84/91.4/100/106.7 cm*



**S02068**  
Ostacolo olimpionico per competizioni, in acciaio con contrappesi, altezza regolabile cm 76,2/84/91,4/100/106,7  
*Olympic competition hurdle made of steel, counterweighted base, adjustable height 76.2/84/91.4/100/106.7 cm*



**S02074**  
Asticella di ricambio per ostacoli in plastica  
*Plastic replacement bar for hurdles*



**S02080**  
Ostacolo per riviera corsa siepi omologato WA per competizioni  
*Water jump steeplechase hurdle WA approved for competition*

**S02082**

Serie ostacoli mobili per corsa siepi in acciaio zincato, travi di legno regolabili in altezza (1 ostacolo cm 500, 3 ostacoli cm 396)

*Set of mobile steeplechase hurdles, galvanized steel structure, wooden bar adjustable height (1 hurdle 500 cm, 3 hurdles 396 cm)*

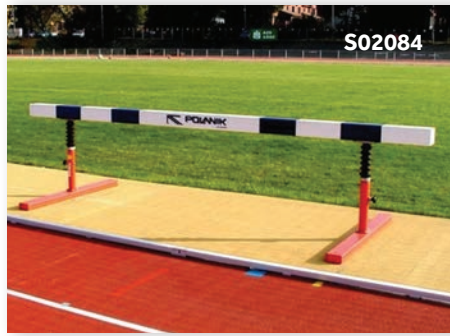
**S02084**

Serie ostacoli mobili per corsa siepi omologati WA per competizioni (1 ostacolo cm 500, 3 ostacoli cm 396)  
*Set of mobile steeplechase hurdles WA approved for competition (1 hurdle 500 cm, 3 hurdles 396 cm)*

**S02086**

Carrello per trasporto ostacoli corsa siepi in acciaio zincato, mobile su ruote  
*Galvanized steel trolley for steeplechase hurdles, mobile on wheels*

3

**Scale e accessori per giudici - Stands and accessories for referees**

S02102

**S02102**

Scala giudici traguardo e cronometristi a 6 posti in acciaio zincato, mobile su ruote

*Judges and timekeepers mobile stand made of galvanized steel, 6 places*

**S02104**

Scala giudici traguardo e cronometristi a 12 posti in acciaio zincato, mobile su ruote

*Judges and timekeepers mobile stand made of galvanized steel, 12 places*



S02106

**S02106**

Tavolo giudici di resina per esterno  
*Judges plastic table for outdoor use*



S02108

**S02108**

Sedia giudici di resina per esterno  
*Judges plastic chair for outdoor use*



S02112

**S02112**

Megafono a transistor portatile  
*Hand transistor megaphone*



S02114

**S02114**

Bandierina per giudici rossa, bianca o gialla  
*Judges flag red, white or yellow*

**S02110**

Ombrellone parasole completo di basamento  
*Outdoor parasol umbrella with plastic base*



S02116

**S02116**  
Contagiri in acciaio zincato con campana  
*Galvanized steel lap indicator with bell*



S02118

**S02118**  
Segnalatore numerico a 8 cifre in acciaio zincato, completo di sedile, mobile su ruote  
*Mobile field event scoreboard in galvanized steel with 8 figures, complete of seat*



S02120

**S02120**  
Segnalatore numerico a 8 cifre in acciaio zincato, su basamento girevole con ruote  
*Mobile revolving field event scoreboard in galvanized steel with 8 figures*



S02122

**S02122**  
Bilancia pesa attrezzi elettronica digitale  
*Digital electronic equipment scale*



S02123

**S02123**  
Kit controllo attrezzi da lancio, su sacca in nylon  
*Set of measuring devices for throwing events, on nylong bag*



S02124

**S02124**  
Sgabello per starter in acciaio zincato mobile su ruote  
*Galvanized steel starter rostrum mobile on wheels*



S02126

**S02126**  
Pistola per starter a tamburo  
*Starting revolver gun*



S02128

**S02128**  
Confezione cartucce per pistola starter  
*Box of blanks for starting revolver gun*

4

Cronometri e articoli per rilevazione tempi - *Stopwatches and timing equipment*

S02154

**S02154**

Cronometro digitale, precisione 1/100 di secondo

*Digital stopwatch, precision 1/100 seconds*



S02158

**S02158**

Cronometro digitale, precisione 1/100 di secondo, 100 memorie

*Digital stopwatch, precision 1/100 seconds, 100 memories*



S02160

**S02160**

Cronometro rilevazione tempi completo di stampante

*Portable timing system with printer*

**S02164**

Ponte porta lampade per fotofinish, in acciaio zincato, per pista a 6 corsie

*Galvanized steel structure for 6 lanes track supporting photofinish lamps*

**S02166**

Ponte porta lampade per fotofinish, in acciaio zincato, per pista a 8 corsie

*Galvanized steel structure for 8 lanes track supporting photofinish lamps*

5

Articoli vari per discipline su pista - *Accessories for track events*

S02202

**S02202**

Piramide segna corsia numerata, di acciaio verniciato

*Varnished steel lane marker box*

**S02206**

Bandierina per rientro al cordolo

*Finish flag with plastic flagpole*

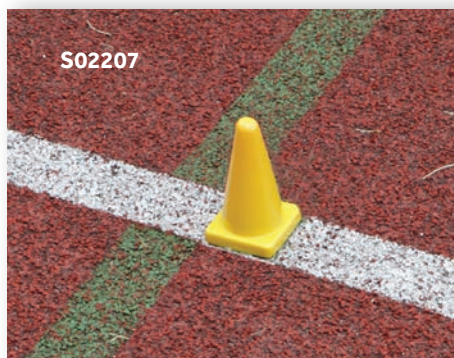

S02207

**S02204**

Piramide segna corsia numerata, di vetroresina

*Fibreglass lane marker box*

**S02207**

Mini cono di segnalazione della riga di rientro

*Mini-cone marking the entry lane*

S02208

**S02208**

Cono di plastica, altezza cm 30

*Plastic marking cone, height 30 cm*



S02210

**S02210**

Cono di plastica, altezza cm 50  
Plastic marking cone, height 50 cm



S02212

**S02212**

Fettuccia segna corsie di plastica in rotoli da mt 150  
White pvc sector line marker tape in roll of 150 mt



S02214

**S02214**

Ferma fettuccia di acciaio zincato  
Galvanized steel fixing pin for marking tape



S02216

**S02216**

Piramide segna settore numerata di acciaio verniciato  
Varnished steel distance marker box



S02218

**S02218**

Piramide segna settore numerata di vetroresina  
Fibreglass distance marker box



S02220

**S02220**

Serie di bandierine segnarecord in acciaio verniciato  
Set of varnished steel record marker flags



S02222

**S02222**

Palina segna lanci numerata di acciaio verniciato  
Varnished steel distance marker



S02224

**S02224**

Coppia pali traguardo in acciaio zincato con bussole da cementare  
Pair of galvanized steel finish posts with sockets to be concreted in

S02226



**S02226**

Podio per vincitori a 3 gradini con struttura in acciaio zincato  
Victory stand at 3 steps with galvanized steel structure



S02228

**S02228**

Podio per vincitori composto da 3 moduli indipendenti in vetroresina  
Victory stand made of 3 separate fibreglass steps



S02230



**S02230**

Panchina doppia per atleti con 8 sedute in polipropilene su struttura in acciaio zincato, mobile su ruote, con copertura  
Mobile athletes double bench with 8 plastic seats mounted onto galvanized steel structure, mobile on wheels, equipped with protective roof

6

## Rotelle metriche - Measuring tapes

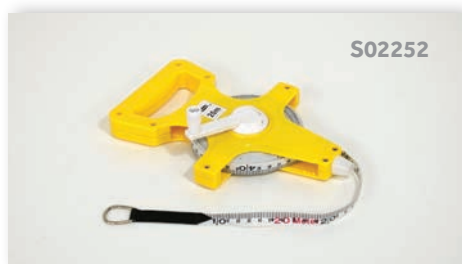
**S02252**

Rotella metrica da mt 20 di fiberglass,  
con impugnatura

*Fibreglass measuring tape 20 mt, with  
handle*

**S02256**

Rotella metrica da mt 20 di acciaio, con  
impugnatura

*Steel measuring tape 20 mt, with handle*

**S02254**

Rotella metrica da mt 50 di fiberglass,  
con impugnatura

*Fibreglass measuring tape 50 mt, with  
handle*

**S02258**

Rotella metrica da mt 50 di acciaio, con  
impugnatura

*Steel measuring tape 50 mt, with handle*

**S02260**

Rotella metrica da mt 100 di acciaio,  
con impugnatura

*Steel measuring tape 100 mt, with  
handle*

**S02262**

Contometri stradale a lettura doppia,  
con maniglia

*Measuring wheel with handle*

7

## Articoli per lancio del disco - Discus throwing equipment

**S02302**

Disco di gomma da allenamento,  
kg 1

*Training rubber discus, 1 kg*

**S02304**

Disco di gomma da allenamento,  
kg 1,500

*Training rubber discus, 1.500 kg*

**S02306**

Disco di gomma da allenamento,  
kg 1,750

*Training rubber discus, 1.750 kg*

**S02308**

Disco di gomma da allenamento,  
kg 2

*Training rubber discus, 2 kg*

**S02310**

Disco da allenamento Polanik di plastica  
bordato acciaio, kg 0,750

*Polanik training plastic discus with steel  
rim, 0.750 kg*

**S02312****S02312**

Disco da allenamento Polanik di plastica  
bordato acciaio, kg 1

*Polanik training plastic discus with steel  
rim, 1 kg*

**S02314**

Disco da allenamento Polanik di plastica  
bordato acciaio, kg 1,500

*Polanik training plastic discus with steel  
rim, 1.500 kg*

**S02316**

Disco da allenamento Polanik di plastica  
bordato acciaio, kg 1,750

*Polanik training plastic discus with steel  
rim, 1.750 kg*

**S02318**

Disco da allenamento Polanik di plastica  
bordato acciaio, kg 2

*Polanik training plastic discus with steel  
rim, 2 kg*





**S02320**

Disco Polanik di nylon bordato acciaio, kg 1 omologato WA per competizioni  
*Polanik nylon discus with steel rim, 1 kg WA approved for competition*

**S02322**

Disco Polanik di nylon bordato acciaio, kg 1,500 omologato WA per competizioni  
*Polanik nylon discus with steel rim, 1.500 kg WA approved for competition*

**S02324**

Disco Polanik di nylon bordato acciaio, kg 1,750 omologato WA per competizioni  
*Polanik nylon discus with steel rim, 1.750 kg WA approved for competition*

**S02326**

Disco Polanik di nylon bordato acciaio, kg 2 omologato WA per competizioni  
*Polanik nylon discus with steel rim, 2 kg WA approved for competition*



**S02328**

Carrello porta dischi in acciaio zincato, mobile su ruote  
*Galvanized steel trolley for discus, mobile on wheels*

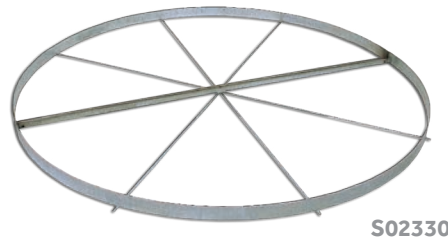

S02330

**S02330**

Pedana per lancio del disco di acciaio zincato, diametro cm 250, in 2 elementi  
*Discus throwing circle made of galvanized steel, diameter 250 cm, made of 2 parts*



S02332

**S02332**

Gabbia di protezione per lancio del disco (e martello) di acciaio zincato, altezza mt 7, completa di rete e portelloni mobili  
*Protective cage for discus (and hammer) throwing made of galvanized steel, height 7 mt, including doors and net*



S02336

**S02336**

Gabbia di protezione per lancio del disco (e martello) in alluminio, omologata WA per competizioni  
*Protective cage for discus (and hammer) throwing made of aluminium, WA approved for competition*

**S02338**

Rete di nylon per gabbia di protezione con altezza mt 7  
*Net for protective cage of 7 mt*

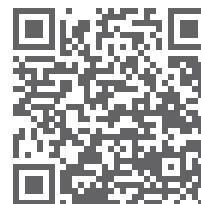

LINK

Inquadra il QR Code di sinistra col tuo cellulare per accedere alla sezione Atletica del sito  
[www.sportssystem.it](http://www.sportssystem.it)

Scan the QR Code at your right with your mobile phone to navigate the Athletics section at  
[www.sportssystem.it](http://www.sportssystem.it) site



S02351

**S02351**

Junior Jav da gr 80 propedeutico al lancio del giavelotto

*Junior Jav of 80 gr for practicing on javelin throwing*

**S02358**

Giavelotto Polanik di alluminio da allenamento, peso gr 600

*Polanik aluminium javelin for training, weight 600 gr*

**S02360**

Giavelotto Polanik di alluminio da allenamento, peso gr 700

*Polanik aluminium javelin for training, weight 700 gr*

**S02366**

Giavelotto Polanik di alluminio, peso gr 600 per lanci fino a mt 60, omologato WA per competizioni

*Polanik aluminium javelin, weight 600 gr, up to 60 mt throw, WA approved for competition*

**S02368**

Giavelotto Polanik di alluminio, peso gr 700 per lanci fino a mt 65, omologato WA per competizioni

*Polanik aluminium javelin, weight 700 gr, up to 65 mt throw, WA approved for competition*



S02352

**S02352**

Turbo Jav propedeutico al lancio del giavelotto

*Turbo Jav practice javelin made in coloured plastic*

**S02362**

Giavelotto Polanik di alluminio da allenamento, peso gr 800

*Polanik aluminium javelin for training, weight 800 gr*

**S02370**

Giavelotto Polanik di alluminio, peso gr 800 per lanci fino a mt 80, omologato WA per competizioni

*Polanik aluminium javelin, weight 800 gr, up to 80 mt throw, WA approved for competition*



S02354

**S02354**

Vortex propedeutico al lancio del giavelotto

*Vortex for practicing on javelin throwing, made in soft plastic*



Competition

**S02364**

Giavelotto Polanik di alluminio da competizione, peso gr 400

*Polanik aluminium javelin for competition, weight 400 gr*



S02372

**S02372**

Carrello porta giavelotti in acciaio zincato, mobile su ruote

*Galvanized steel trolley for javelins, mobile on wheels*



Training

**S02356**

Giavelotto Polanik di alluminio da allenamento, peso gr 400

*Polanik aluminium javelin for training, weight 400 gr*

**S02365**

Giavelotto Polanik di alluminio da competizione, peso gr 500

*Polanik aluminium javelin for competition, weight 500 gr*



S02374

**S02374**

Borsa per trasporto giavelotti, capacità 5 pezzi

*Javelin bag holding 5 javelins*

Articoli per lancio del martello - Hammer throwing equipment



**S02402**

Martello da allenamento Polanik di ferro tornito e calibrato, peso kg 3  
*Polanik turned steel hammer for training, weight 3 kg*

**S02404**

Martello da allenamento Polanik di ferro tornito e calibrato, peso kg 4  
*Polanik turned steel hammer for training, weight 4 kg*

**S02406**

Martello da allenamento Polanik di ferro tornito e calibrato, peso kg 5  
*Polanik turned steel hammer for training, weight 5 kg*

**S02408**

Martello da allenamento Polanik di ferro tornito e calibrato, peso kg 6  
*Polanik turned steel hammer for training, weight 6 kg*

**S02410**

Martello da allenamento Polanik di ferro tornito e calibrato, peso kg 7,260  
*Polanik turned steel hammer for training, weight 7.260 kg*

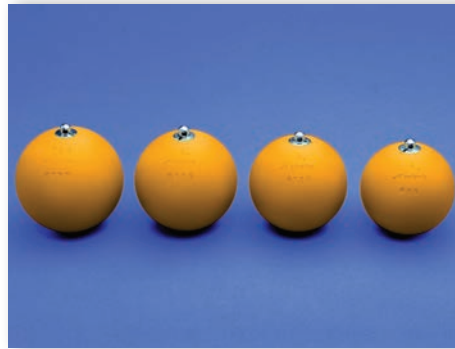

**S02412**

Martello Polanik di ferro tornito e calibrato da gara, peso kg 4, omologato WA per competizioni  
*Polanik turned steel hammer, weight 4 kg, WA approved for competition*

**S02414**

Martello Polanik di ferro tornito e calibrato da gara, peso kg 5, omologato WA per competizioni  
*Polanik turned steel hammer, weight 5 kg, WA approved for competition*

**S02416**

Martello Polanik di ferro tornito e calibrato da gara, peso kg 6, omologato WA per competizioni  
*Polanik turned steel hammer, weight 6 kg, WA approved for competition*

**S02418**

Martello Polanik di ferro tornito e calibrato da gara, peso kg 7,260, omologato WA per competizioni  
*Polanik turned steel hammer, weight 7.260 kg, WA approved for competition*



S02422

**S02422**

Carrello porta martelli in acciaio zincato, mobile su ruote  
*Galvanized steel trolley for hammers, mobile on wheels*



S02424

**S02424**

Anello di riduzione da pedana lancio disco a pedana lancio martello, componibile in 4 elementi di legno  
*Reduction circle to convert discus to hammer platforms, consist of 4 wooden parts*



S02426

**S02426**

Gabbia di protezione per lancio del martello (e disco) in alluminio, omologata WA per competizioni  
*Protective cage for hammer (and discus) throwing made of aluminium, WA approved for competition*



S02422



S02420

**S02420**

Filo per martello completo di maniglia  
*Wire for hammer including handle*

**S02452**

Palla getto di gomma anelastica per uso indoor, kg 0,150  
*Rubber practice throwing ball, not bouncing, 0.150 kg*

**S02468**

Palla getto di gomma anelastica per uso indoor, kg 5  
*Rubber practice throwing ball, not bouncing, 5 kg*

**S02454**

Palla getto di gomma anelastica per uso indoor, kg 0,300  
*Rubber practice throwing ball, not bouncing, 0.300 kg*

**S02470**

Palla getto di gomma anelastica per uso indoor, kg 6  
*Rubber practice throwing ball, not bouncing, 6 kg*

**S02456**

Palla getto di gomma anelastica per uso indoor, kg 0,500  
*Rubber practice throwing ball, not bouncing, 0.500 kg*

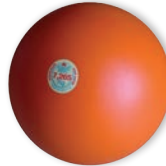
**S02472**

Palla getto di gomma anelastica per uso indoor, kg 7,260  
*Rubber practice throwing ball, not bouncing, 7.260 kg*

**S02458**

Palla getto di gomma anelastica per uso indoor, kg 0,800  
*Rubber practice throwing ball, not bouncing, 0.800 kg*

**S02460**

Palla getto di gomma anelastica per uso indoor, kg 1  
*Rubber practice throwing ball, not bouncing, 1 kg*

**S02474**

Palla getto di gomma kg 2  
*Rubber shot ball 2 kg*

**S02480**

Palla getto di gomma kg 5  
*Rubber shot ball 5 kg*

**S02462**

Palla getto di gomma anelastica per uso indoor, kg 2  
*Rubber practice throwing ball, not bouncing, 2 kg*

**S02476**

Palla getto di gomma kg 3  
*Rubber shot ball 3 kg*

**S02482**

Palla getto di gomma kg 6  
*Rubber shot ball 6 kg*

**S02464**

Palla getto di gomma anelastica per uso indoor, kg 3  
*Rubber practice throwing ball, not bouncing, 3 kg*

**S02478**

Palla getto di gomma kg 4  
*Rubber shot ball 4 kg*

**S02484**

Palla getto di gomma kg 7,260  
*Rubber shot ball 7.260 kg*

**S02466**

Palla getto di gomma anelastica per uso indoor, kg 4  
*Rubber practice throwing ball, not bouncing, 4 kg*



S02486

**S02486**

Palla getto di metallo verniciato da allenamento, tarata kg 2  
*Varnished metal shot ball for training, gauged 2 kg*

**S02488**

Palla getto di metallo verniciato da allenamento, tarata kg 3  
*Varnished metal shot ball for training, gauged 3 kg*

**S02490**

Palla getto di metallo verniciato da allenamento, tarata kg 4  
*Varnished metal shot ball for training, gauged 4 kg*

**S02492**

Palla getto di metallo verniciato da allenamento, tarata kg 5  
*Varnished metal shot ball for training, gauged 5 kg*

**S02494**

Palla getto di metallo verniciato da allenamento, tarata kg 6  
*Varnished metal shot ball for training, gauged 6 kg*

**S02496**

Palla getto di metallo verniciato da allenamento, tarata kg 7,260  
*Varnished metal shot ball for training, gauged 7.260 kg*

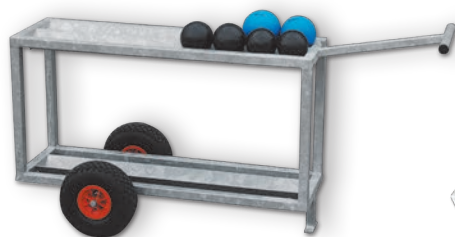

S02508



S02498

**S02498**

Palla getto Polanik di ferro tornito e calibrato, peso kg 3, omologata WA per competizioni  
*Polanik turned steel shot ball, weight 3 kg, WA approved for competition*

**S02500**

Palla getto Polanik di ferro tornito e calibrato, peso kg 4, omologata WA per competizioni  
*Polanik turned steel shot ball, weight 4 kg, WA approved for competition*

**S02502**

Palla getto Polanik di ferro tornito e calibrato, peso kg 5, omologata WA per competizioni  
*Polanik turned steel shot ball, weight 5 kg, WA approved for competition*

**S02504**

Palla getto Polanik di ferro tornito e calibrato, peso kg 6, omologata WA per competizioni  
*Polanik turned steel shot ball, weight 6 kg, WA approved for competition*

**S02506**

Palla getto Polanik di ferro tornito e calibrato, peso kg 7,260, omologata WA per competizioni  
*Polanik turned steel shot ball, weight 7.260 kg, WA approved for competition*



S02514



S02508

**S02508**

Carrello porta palle getto in acciaio zincato, mobile su ruote  
*Galvanized steel trolley for shot balls, mobile on wheels*

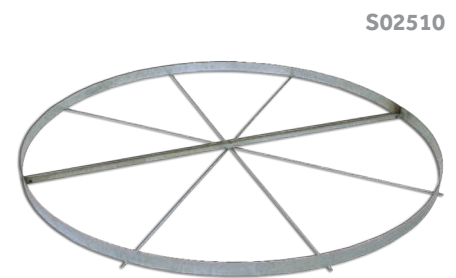

S02510

**S02510**

Pedana per lancio del peso di acciaio zincato, diametro cm 213,5 in 2 elementi  
*Shot put throwing circle made of galvanized steel, diameter 213.5 cm made of 2 parts*



S02512

**S02512**

Fermapiede getto del peso di legno massiccio  
*Shot put toe board made of wood*

**S02514**

**NEW**

Fermapiede getto del peso di vetroresina, omologato WA per competizioni  
*Shot put toe board made of fibreglass, WA approved for competition*

## Articoli per salto in alto - High jump equipment

S02552

**S02552**

Coppia ritti per salto in alto scolastici, altezza regolabile fino a cm 200  
*Pair of practice high jump stands, height adjustable up to 200 cm*

S02554

**S02554**

Coppia ritti per salto in alto scolastici, altezza regolabile fino a cm 230  
*Pair of practice high jump stands, height adjustable up to 230 cm*

S02556

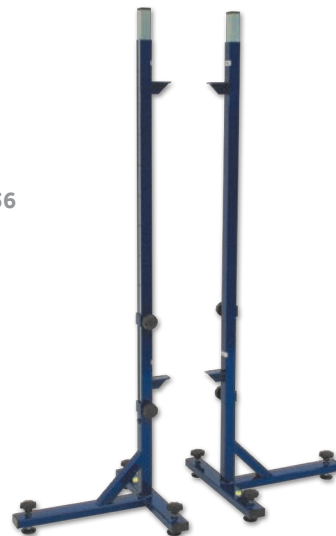
**S02556**

Coppia ritti per salto in alto telescopici, altezza regolabile fino a cm 250  
*Pair of high jump stands, height telescopically adjustable up to 250 cm*

S02558

**S02558**

Coppia ritti per salto in alto da gara, regolazione telescopica dell'altezza fino a cm 260  
*Pair of professional high jump stands, height telescopically adjustable up to 260 cm*

S02560

**S02560**

Coppia ritti salto in alto di alluminio da gara, altezza regolabile fino a cm 260  
*Pair of professional high jump stands made of aluminium, height adjustable up to 260 cm*

S02561

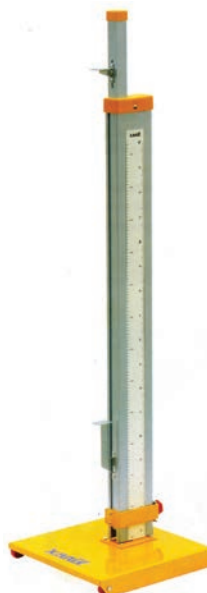
**S02561**

Coppia ritti salto in alto di alluminio, regolazione telescopica dell'altezza, omologati WA per competizioni  
*Pair of professional high jump stands, telescopic, WA approved for competition*

S02562

**S02562**

Coppia ritti salto in alto di alluminio, regolazione telescopica dell'altezza fino a cm 265, omologati WA per competizioni  
*Pair of professional high jump stands, height telescopically adjustable up to 265 cm, WA approved for competition*

S02566



**S02566**

Asticella segna limite di polietilene espanso, lunghezza mt 4  
Polyethylene foam high jump crossbar, length 4 mt

**S02576**

Area di caduta salto in alto, dimensione cm 400x300x50  
High jump landing area, dimension 400x300x50 cm



S02578



**S02578**

Area di caduta salto in alto, dimensione cm 500x300x60  
High jump landing area, dimension 500x300x60 cm

**S02580**

Area di caduta salto in alto, dimensione cm 600x300x70  
High jump landing area, dimension 600x300x70 cm

**S02582**

Area di caduta salto in alto, dimensione cm 600x400x70  
High jump landing area, dimension 600x400x70 cm

**S02584**

Piattaforma di sostegno e sollevamento area di caduta in acciaio zincato  
Galvanized steel support platform for raising the high jump landing area



S02584



S02586

**S02586**

Segnalino di rincorsa di acciaio colorato  
Coloured steel run up marker



S02572

S02570

**S02570**

Asticella segna limite di vetroresina, modello da allenamento, lunghezza mt 4  
Fibreglass high jump crossbar for training, length 4 mt

**S02572**

Asticella segna limite di vetroresina, modello da competizione, lunghezza mt 4  
Fibreglass high jump crossbar for competition, length 4 mt



S02574

**S02574**

Misuratore di alluminio per salto in alto  
Aluminium height measurer for high jump

12

**Articoli per salto con l'asta**  
*Pole vault equipment*



S02602

**S02602**

Coppia ritti per salto con l'asta di alluminio, altezza regolabile fino a cm 650  
Pair of aluminium pole vault stands, height adjustable up to 650 cm



S02603

**S02603**

Coppia ritti per salto con l'asta di alluminio, altezza regolabile fino a cm 650, omologati WA per competizioni

*Pair of aluminium pole vault stands, height adjustable up to 650 cm, WA approved for competition*



S02604

ZOOM

ZOOM

**S02604**

Coppia ritti per salto con l'asta di alluminio, altezza regolabile fino a cm 640, lettura elettronica, omologati WA per competizioni

*Pair of aluminium pole vault stands, height adjustable up to 640 cm, electronic height indicator, WA approved for competition*



S02610

S02608

**S02608**

Asticella segna limite di vetroresina, modello da allenamento, lunghezza mt 4,50

*Fibreglass pole vault crossbar for training, length 4.50 mt*

**S02610**

Asticella segna limite di vetroresina, modello da competizione, lunghezza mt 4,50

*Fibreglass pole vault crossbar for competition, length 4.50 mt*



S02612

**S02612**

Misuratore di alluminio per salto con l'asta

*Aluminium height measurer for pole vault*

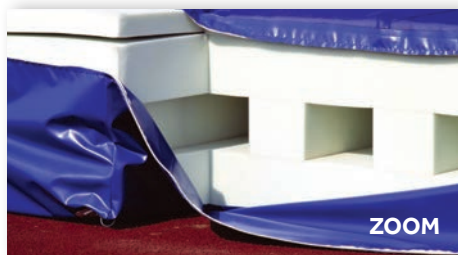

ZOOM

**S02614**

Area di caduta salto con l'asta, dimensione cm 700x500x80

*Pole vault landing area, dimension 700x500x80 cm*

**S02616**

Area di caduta salto con l'asta, dimensione cm 600x700x80

*Pole vault landing area, dimension 600x700x80 cm*

**S02618**

Area di caduta salto con l'asta, dimensione cm 600x800x80

*Pole vault landing area, dimension 600x800x80 cm*



S02620

**S02620**

Piattaforma di sostegno e sollevamento area di caduta in acciaio zincato

*Galvanized steel support platform for raising the pole vault landing area*



S02622 - ZOOM

**S02622**

Asta per salto con l'asta di fibra di vetro, lunghezza e portata a richiesta

*Fibreglass vaulting pole, length and loading capacity on demand*



S02624

**S02624**

Segnalino di rincorsa di acciaio colorato

*Coloured steel run up marker*



S02626

**S02626**

Cassetta per imbucata asta di acciaio zincato con coperchio

*Galvanized steel vault box with cover*



Articoli per salto in lungo e triplo - Long and triple jump equipment



S02652

**S02652**

Asse di battuta in legno per salto in lungo e salto triplo con tavoletta porta plastilina

*Sturdy wooden take-off board for long and triple jump with wooden insert for plasticine*

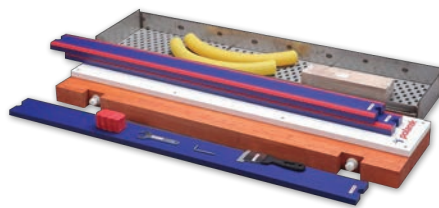

S02658

**S02658**

Asse di battuta in legno per salto in lungo e salto triplo con cassetta di acciaio inox ed accessori, omologata WA per competizioni

*Sturdy wooden take-off board for long and triple jump with stainless steel box and accessories, WA approved for competition*



S02664

**S02664**

Rastrello livellatore per buca sabbia, di acciaio zincato

*Galvanized steel rake for sandbox*



S02654

**S02654**

Asse di battuta in acciaio inox e superficie di legno per salto in lungo e salto triplo con tavoletta porta plastilina

*Stainless steel take-off board with wooden surface for long and triple jump with wooden insert for plasticine*



S02660

**S02660**

Coppia indicatori asse di battuta in acciaio verniciato

*Pair of varnished steel take-off markers*



S02666

**S02666**

Cazzuola per riempimento cassaforma, di acciaio trattato

*Steel coated trowel to fill mould*



S02656

**S02656**

Cassetta in acciaio zincato per asse di battuta

*Galvanized steel box for take-off board*



S02662

**S02662**

Cassaforma per sabbia in acciaio zincato

*Galvanized steel sand box*





## GIOCHI

Nella categoria Giochi trovano spazio una serie di sottocategorie di articoli ed attrezzature destinate alla pratica dei principali sport individuali e di squadra, a partire **da soluzioni di livello scolastico fino ad alternative omologate per competizioni** dalle rispettive federazioni internazionali.

**Tutte le soluzioni presentate**, fisse o mobili, per uso indoor o outdoor, **sono agevolmente personalizzabili** in base alle diverse esigenze dei clienti.



## GAMES

*This category includes a range of equipment and accessories dedicated to the practice of main individual and team sports, starting **from school level up to professional level** with a selection of alternatives approved by the relevant international sporting federation.*

***All solutions**, portable or fixed, for indoor or outdoor purposes, **can be easily customized** to customer's requirements.*



1

## Strutture ricreative basket, minibasket e baskin Recreational basket, mini-basket and baskin units



S04007

**S04007**

Struttura trasportabile per gioco baskin, base zavorrabile, palo in acciaio, tabellone in polipropilene, canestri fissi con retina

*Portable baskin unit, base to be filled, steel column, polypropylene backboard and fixed rings with net*



S04008

**S04008**

Struttura basket e minibasket trasportabile, base zavorrabile, palo in acciaio, tabellone in polipropilene con canestro fisso e retina

*Portable basket and mini-basket unit, base to be filled, steel column, polypropylene backboard and fixed ring with net*



S04010

**S04010**

Struttura basket e minibasket trasportabile, base zavorrabile, palo in acciaio, tabellone in polipropilene con canestro fisso e retina, regolazione automatica dell'altezza

*Portable basket and mini-basket unit, base to be filled, steel column, polypropylene backboard and fixed ring with net, automatic height adjustment*



S04011

**S04011**

Protezione frontale imbottita per strutture basket e minibasket S04008 e S04010

*Front protection pad for basket and mini-basket units S04008 and S04010*



S04012

**S04012**

Struttura basket e minibasket richiudibile e trasportabile in acciaio verniciato, base porta zavorra, tabellone in resina, canestro fisso e retina, protezione frontale

*Foldable and portable basket and mini-basket unit entirely in varnished steel, platform supporting ballast, hpl backboard, fixed ring with net, front protection pad*



S04014

**S04014**

Struttura basket e minibasket monotubolare in acciaio verniciato, mobile su ruote e pieghevole, tabellone in plexiglas, canestro fisso e retina, protezione frontale, zavorra inclusa

*Foldable monotubular basket and mini-basket unit movable on wheels, in varnished steel, acrylic glass backboard, fixed ring with net, front protection pad, ballast included*

2

## Impianti basket a traliccio e monotubolari *Olympic and monotubular basketball backstops*

NOTE

Tutti gli impianti basket presenti in questa sezione sono forniti con canestri S04232.

*All basketball backstops included in this section are supplied with rings S04232.*



S04020

### S04020

Impianto basket olimpionico a traliccio di acciaio zincato, sbalzo cm 225, tabelloni di resina melamminica su telaio, canestri fissi e retine

*Olympic basketball backstops, galvanized steel structure projection 225 cm, hpl backboards on steel frame, fixed rings and nets*

### S04022

Impianto basket olimpionico a traliccio di acciaio verniciato, sbalzo cm 225, tabelloni di nobilitato bilaminato su telaio, canestri fissi e retine

*Olympic basketball backstops, varnished steel structure projection 225 cm, chipboard backboards on steel frame, fixed rings and nets*



S04024 + S04028



ZOOM

### S04024

Impianto basket olimpionico a traliccio di acciaio zincato con cassone porta zavorra, mobile con carrello, sbalzo cm 225, tabelloni di resina melamminica su telaio, canestri fissi e retine

*Olympic basketball backstops with ballast box, galvanized steel structure projection 225 cm, mobile on trolley, hpl backboards on steel frame, fixed rings and nets*

### S04026

Impianto basket olimpionico a traliccio di acciaio verniciato con cassone porta zavorra, mobile con carrello, sbalzo cm 225, tabelloni di nobilitato bilaminato su telaio, canestri fissi e retine

*Olympic basketball backstops with ballast box, varnished steel structure projection 225 cm, mobile on trolley, chipboard backboards on steel frame, fixed rings and nets*

NOTE

Impianti basket S04022 e S04026 possono essere verniciati di qualsiasi colore RAL, a richiesta.

*Basketball backstops S04022 and S04026 can be varnished in any RAL color, on demand.*

### S04028

Coppia protezioni frontali per impianto basket olimpionico  
*Pair of front protection pads for olympic model basketball backstops*

## NOTE

Tutti gli impianti basket presenti in questa sezione sono forniti con canestri S04232.

All basketball backstops included in this section are supplied with rings S04232.



## S04030



Impianto basket monotubolare di acciaio zincato, struttura con sbalzo cm 225 realizzata in unico elemento, tabelloni di resina melamminica su telaio con tirante di rinforzo, canestri fissi e retine

*Monotubular basketball backstops, galvanized steel structure projection 225 cm made of unique element, hpl backboards on steel frame with reinforcing tie bar, fixed rings and nets*



S04030



S04032 + S04034



ZOOM

## S04032



Impianto basket monotubolare di acciaio zincato, struttura con sbalzo cm 225 realizzata in 2 elementi unibili con viti, tabelloni di resina melamminica su telaio con tiranti di rinforzo, canestri fissi e retine

*Monotubular basketball backstops, galvanized steel structure projection 225 cm made of 2 separate elements, hpl backboards on steel frame with reinforcing tie bars, fixed rings and nets*



## S04034

Coppia protezioni frontali per impianto basket monotubolare S04030 e S04032

*Pair of front protection pads for monotubular basketball backstops S04030 and S04032*



S04036 + S04037

**S04036** ✓ EN1270 tested

Impianto basket e minibasket monotubolare di acciaio zincato (altezza regolabile manualmente), struttura con sbalzo cm 225, tabelloni di resina melamminica su telaio, canestri fissi e retine

*Monotubular basketball and mini-basketball backstops (height manually adjustable), galvanized steel structure projection 225 cm, hpl backboards on steel frame, fixed rings and nets*

**S04037**

Coppia protezioni frontali per impianto basket monotubolare S04036

*Pair of front protection pads for monotubular basketball backstops S04036*

**S04038**

Impianto basket monotubolare di acciaio zincato su base con cassone porta zavorra, mobile con carrello, sbalzo cm 165, tabelloni di resina melamminica su telaio con tirante di rinforzo, canestri fissi e retine

*Monotubular basketball backstops, galvanized steel structure on base with ballast box, mobile on trolley, projection 165 cm, hpl backboards on steel frame with reinforcing tie bar, fixed rings and nets*



S04038

**NOTE**

Gli impianti basket **S04030**, **S04032** e **S04036** possono essere realizzati anche con sbalzo diverso e forniti con tabelloni in plexiglas e canestri reclinabili, a richiesta.

*Basketball backstops **S04030**, **S04032** and **S04036** can be produced with different projection and supplied with acrylic glass backboards and reclining rings, on demand.*



S04040

**S04040**

Coppia protezioni frontali per impianto pallacanestro S04038. Pannello di legno imbottito e rivestito di PVC lavabile, forma triangolare con altezza cm 200. Fissaggio a mezzo viti.

*Pair of protective pads for basketball backstops S04038. Padded wooden board covered with PVC fabric, triangular shape, height 200 cm. To be fixed with screws.*

3

### Impianti basket a parete e a soffitto *Wall and roof mounted basketball backstops*



S04056

#### S04056

Impianto basket a muro con sbalzo cm 185, tabelloni in nobilitato bilaminato su telaio, canestri fissi e retine  
*Wall mounted basketball backstops, projection 185 cm, chipboard backboards on steel frame, fixed rings and nets*

#### S04058

Impianto basket a muro con sbalzo cm 325, tabelloni in nobilitato bilaminato su telaio, canestri fissi e retine  
*Wall mounted basketball backstops, projection 325 cm, chipboard backboards on steel frame, fixed rings and nets*

#### NOTE

Gli impianti basket **S04056** e **S04058** possono essere forniti con tabelloni in plexiglas o cristallo e canestri reclinabili, a richiesta.

*Basketball backstops S04056 and S04058 can be supplied with acrylic or tempered glass backboards and reclining rings, on demand.*

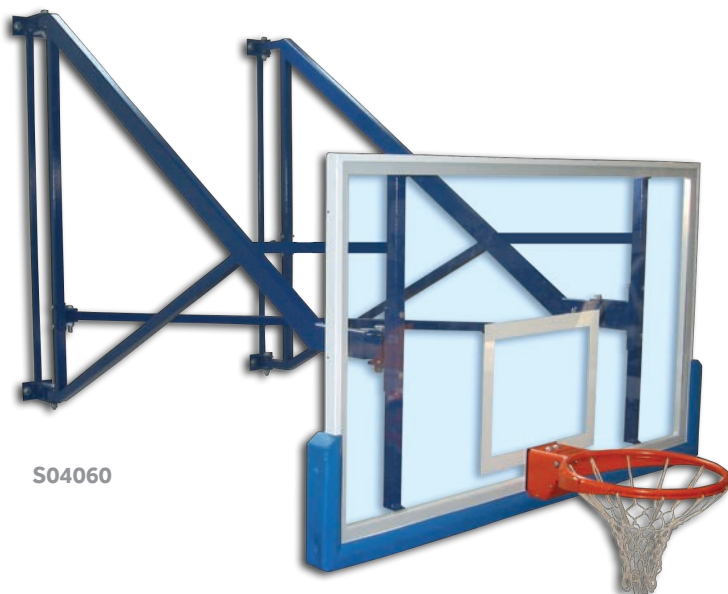

S04060

#### S04060

Impianto basket a muro chiudibile lateralmente, soluzione economica standard con sbalzo cm 225, tabelloni in cristallo temperato su telaio con protezione, canestri reclinabili e retine  
*Wall mounted side folding basketball backstops, simple standard construction 225 cm projection, tempered glass backboards on steel frame with pad, reclining rings and nets*

#### S04062

Impianto basket a muro chiudibile lateralmente, soluzione economica standard con sbalzo cm 225, tabelloni in nobilitato bilaminato su telaio, canestri fissi e retine  
*Wall mounted side folding basketball backstops, simple standard construction 225 cm projection, chipboard backboards on steel frame, fixed rings and nets*

#### NOTE

Gli impianti basket **S04056**, **S04058**, **S04060**, **S04062**, **S04064** e **S04066** possono essere realizzati anche con sbalzo diverso, a richiesta.

*Basketball backstops S04056, S04058, S04060, S04062, S04064 and S04066 can be produced with different projection, on demand.*





level 2



S04064  
Posizione di chiusura  
Closed at side



S04064  
Posizione minibasket  
Mini-basket position



S04064

Impianto basket Trevi a muro chiudibile lateralmente, sbalzo cm 325, tabelloni in cristallo temperato su telaio con protezione, canestri reclinabili e retine; omologato FIBA per competizioni di 2° livello

*Wall mounted side folding basketball backstops Trevi, 325 cm projection, tempered glass backboards on steel frame with pad, reclining rings and nets; FIBA approved for 2nd level competitions*

S04066

Impianto basket Trevi a muro chiudibile lateralmente, sbalzo cm 325, tabelloni in nobilitato bilaminato su telaio, canestri fissi e retine

*Wall mounted side folding basketball backstops Trevi, 325 cm projection, chipboard backboards on steel frame, fixed rings and nets*

S04067

Kit motorizzazione impianto basket Trevi a muro chiudibile lateralmente (S04064, S04066)

*Kit for motorizing the pair of wall mounted side folding basketball backstops (S04064, S04066)*

NOTE

Gli impianti basket **S04064** e **S04066** possono essere forniti, a richiesta, con motorizzazione **S04067** per la gestione del movimento di apertura e chiusura.

*Wall mounted side folding basketball backstops **S04064** and **S04066** can be equipped, on demand, with **S04067** motorization for opening and closing.*





**S04070**  
Chiusura posteriore  
Backward closure

### S04070

✓ EN1270 tested

Impianto basket Top a soffitto chiudibile frontalmente o posteriormente verso l'alto, motorizzato, struttura realizzata a disegno, tabelloni in cristallo temperato su telaio con protezione, canestri reclinabili e retine; omologato FIBA per competizioni di 2° livello  
*Roof mounted forward or backward up folding motorized basketball backstops Top, customized construction, tempered glass backboards on steel frame with pad, reclining rings and nets; FIBA approved for 2nd level competitions*



level 2

### S04074

Coppia dispositivi meccanici in acciaio verniciato per regolazione dell'altezza dei tabelloni degli impianti basket a muro e a soffitto (basket e minibasket)  
*Pair of mechanical devices for adjusting backboards' height on wall and roof mounted basketball backstops (basket and mini-basket)*



S04074

Video dimostrativo del funzionamento del dispositivo minibasket **S04074** disponibile al sito [www.sportssystem.it](http://www.sportssystem.it) nella sezione **filmati**.

Demonstrative video concerning usage of adjusting device **S04074** available at [www.sportssystem.it](http://www.sportssystem.it) in movies section.

### S04076

Dispositivo anticaduta di sicurezza per impianti basket S04070, a norma DIN EN 360  
*Crash protection device for basketball backstops S04070, accordingly to DIN EN 360 standard*



## Impianti basket mobili su ruote Portable basketball backstops

### NOTE



Sport System presenta una completa linea di impianti basket omologati FIBA per competizioni internazionali (1° livello), frutto di oltre 40 anni di esperienza maturata nella progettazione e realizzazione di attrezzature per il basket e della fattiva partecipazione nel centro studi FIBA "Equipment and Venue" (già "FIBA research and study centre").

*Sport System presents a complete line of portable basketball backstops FIBA approved for International competitions (1st level), that have been developed as a result of company's more than 40 years experience in designing and manufacturing basketball equipment along with the active participation in the FIBA "Equipment and Venue" centre (former "FIBA research and study centre").*



**S04100**

Impianto Hydroplay ACE mobile su ruote, sbalzo cm 325, sistema oleodinamico elettrico di regolazione dell'altezza e per la gestione indipendente delle ruote, tabelloni di cristallo temperato con protezione, canestri reclinabili e retine; omologato FIBA per competizioni di 1° livello

*Hydroplay ACE portable basketball backstops mobile on wheels, projection 325 cm, oleodynamic electric device for height adjustment and independent control of transport wheels, glass backboards with pad, reclining rings with net; FIBA approved for 1st level competitions*

S04100

**NOTE**

Gli impianti basket delle linee **Hydroplay** e **Easyplay** sono personalizzabili nella scelta dei colori, a richiesta.

*Portable basketball backstops of **Hydroplay** and **Easyplay** lines can be customized on colors combination, on demand.*



**S04102****NEW**

Impianto Hydroplay REX mobile su ruote, sbalzo cm 325, sistema oleodinamico elettrico di regolazione dell'altezza e per la gestione delle ruote, tabelloni di cristallo temperato con protezione, canestri reclinabili e retine; omologato FIBA per competizioni di 1° livello  
*Hydroplay REX portable basketball backstops mobile on wheels, projection 325 cm, oleodynamic electric device for height adjustment and control of wheels, glass backboards with pad, reclining rings with net; FIBA approved for 1st level competitions*



level 1

**S04103**

Impianto Hydroplay 2.0 mobile su ruote, sbalzo cm 325, sistema oleodinamico elettrico di regolazione dell'altezza con dispositivi elettronici di bloccaggio alla quota basket o minibasket, tabelloni in cristallo temperato con protezione, canestri reclinabili e retine; omologato FIBA per competizioni di 1° livello  
*Hydroplay 2.0 portable basketball backstops mobile on wheels, projection 325 cm, oleodynamic electric height adjustment with electronic devices to stop movement both at basket and mini-basket standard, glass backboards with pad, reclining rings with net; FIBA approved for 1st level competitions*



level 1

**S04106**

Impianto Hydroplay Official mobile su ruote, sbalzo cm 325, sistema oleodinamico manuale di regolazione dell'altezza, tabelloni di cristallo temperato con protezione, canestri reclinabili e retine; omologato FIBA per competizioni di 1° livello

*Hydroplay Official portable basketball backstops mobile on wheels, projection 325 cm, oleodynamic manual height adjustment, glass backboards with pad, reclining rings with net; FIBA approved for 1st level competitions*



S04106 - S04108

**S04108**

Impianto Hydroplay Official mobile su ruote, come S04106 ma oleodinamico elettrico

*Hydroplay Official portable basketball backstops, like S04106 with oleodynamic electric height adjustment*



**Video dimostrativi del funzionamento degli impianti basket delle linee Hydroplay e Easyplay disponibili al sito [sportsystem.it](http://sportsystem.it) nella sezione **filmati**.**

***Demonstrative videos about the usage of portable basketball backstops of Hydroplay and Easyplay lines available at [sportsystem.it](http://sportsystem.it) in movies section.***



S04110

**S04110**

Impianto Easyplay Official mobile su ruote, sbalzo cm 325, sistema meccanico a contrappeso di regolazione dell'altezza, tabelloni di cristallo temperato con protezione, canestri reclinabili e retine; omologato FIBA per competizioni di 1° livello

*Easyplay Official portable basketball backstops mobile on wheels, projection 325 cm, mechanical counterweight height adjustment, glass backboards with pad, reclining rings with net; FIBA approved for 1st level competitions*

**S04111**

Impianto Hydroplay ACE mobile su ruote, sbalzo cm 225, sistema oleodinamico manuale di regolazione dell'altezza, tabelloni di cristallo temperato con protezione, canestri reclinabili e retine  
*Hydroplay ACE portable basketball backstops mobile on wheels, projection 225 cm, oleodynamic manual height adjustment, glass backboards with pad, reclining rings with net*



S04111

**NOTE**

Gli impianti basket delle linee **Hydroplay** e **Easyplay** sono personalizzabili nella scelta dei colori, a richiesta.

*Portable basketball backstops of **Hydroplay** and **Easyplay** lines can be customized on colors combination, on demand.*



level 2

**S04113**

Impianto Easyplay Training mobile su ruote, sbalzo cm 225, sistema meccanico a contrappeso di regolazione dell'altezza, tabelloni di cristallo temperato con protezione, canestri reclinabili e retine; omologato FIBA per competizioni di 2° livello

*Easyplay Training portable basketball backstops mobile on wheels, projection 225 cm, mechanical counterweight height adjustment, glass backboards with pad, reclining rings with net; FIBA approved for 2nd level competitions*



S04113



S04114 - S04116

**S04114**

Impianto Hydroplay Training mobile su ruote, sbalzo cm 225, sistema oleodinamico manuale di regolazione dell'altezza, tabelloni di cristallo temperato con protezione, canestri reclinabili e retine  
*Hydroplay Training portable basketball backstops mobile on wheels, projection 225 cm, oleodynamic manual height adjustment, glass backboards with pad, reclining rings with net*

**S04116**

Impianto Hydroplay Training mobile su ruote, come S04114 ma oleodinamico elettrico  
*Hydroplay Training portable basketball backstops, like S04114 with oleodynamic electric height adjustment*

**S04115**

Impianto Hydroplay Training mobile su ruote, sbalzo cm 325, sistema oleodinamico manuale di regolazione dell'altezza, tabelloni di cristallo temperato con protezione, canestri reclinabili e retine  
*Hydroplay Training portable basketball backstops mobile on wheels, projection 325 cm, oleodynamic manual height adjustment, glass backboards with pad, reclining rings with net*



S04115 - S04117

**S04117**

Impianto Hydroplay Training mobile su ruote, come S04115 ma oleodinamico elettrico  
*Hydroplay Training portable basketball backstops, like S04115 with oleodynamic electric height adjustment*





level 2



S04118 - S04120

**S04118**

Impianto Hydroplay Club mobile su ruote, sbalzo cm 225, sistema oleodinamico manuale di regolazione dell'altezza, tabelloni di cristallo temperato con protezione, canestri reclinabili e retine; omologato FIBA per competizioni di 2° livello

*Hydroplay Club portable basketball backstops mobile on wheels, projection 225 cm, oleodynamic manual height adjustment, glass backboards with pad, reclining rings with net; FIBA approved for 2nd level competitions*

**S04120**

Impianto Hydroplay Club mobile su ruote, come S04118 ma oleodinamico elettrico

*Hydroplay Club portable basketball backstops, like S04118 with oleodynamic electric height adjustment*



S04121

**NOTE**

**Gli impianti basket con sbalzo standard cm 225 possono essere realizzati con sbalzo cm 275 o diverso, a richiesta.**

***Portable basketball backstops with standard projection 225 cm can be produced with projection 275 cm or different, on demand.***

**S04121**

Impianto Easyplay Club mobile su ruote, sbalzo cm 225, sistema di movimentazione a molle, tabelloni di cristallo temperato con protezione, canestri reclinabili e retine

*Easyplay Club portable basketball backstops mobile on wheels, projection 225 cm, springs assisted height adjustment, glass backboards with pad, reclining rings with net*



S04124

S04124

✓ EN1270 tested

Impianto Easyplay College mobile su ruote, sbalzo cm 125, sistema meccanico a manovella di regolazione dell'altezza, tabelloni di nobilitato bilaminato, canestri fissi e retine

*Easyplay College portable basketball backstops mobile on wheels, projection 125 cm, mechanical height adjustment, chipboard backboards, fixed rings with net*

## NOTE

L'impianto basket S04124 può essere fornito con tabelloni in plexiglas trasparente completi di protezione (S04206), canestri reclinabili (S04234) con retina e protezioni laterali della base, a richiesta.

*Basketball backstops S04124 can be equipped as well with transparent acrylic backboards with pad (S04206), reclining rings (S04234) with net and soft cushions on sides of the base, on demand.*



S04126

Coppia supporti pieghevoli in acciaio verniciato per indicatori elettronici 24", adattabili ad impianti basket Hydroplay e Easyplay  
*Pair of varnished steel foldable supports for 24" electronic shot clocks to be installed on Hydroplay and Easyplay backstops*



S04126

**NOTE**  
Esempi di personalizzazione dei supporti S04126 in funzione del modello di indicatore 24" in uso e del tipo di impianto basket mobile su ruote.

*Examples of customization of supports S04126 depending on model of 24" shot clocks and type of portable basketball backstops.*



S04129

S04129

Contenitore porta zavorra aggiuntiva in acciaio verniciato con copertura in PVC, applicabile a tutti gli impianti mobili su ruote. Capienza 4 blocchi S04130

*Extra ballast container made of varnished steel with PVC cover, to be applied on back side of any portable basketball backstops. Capacity 4 cubes S04130*



S04130

S04130

Blocco zavorra per impianti basket mobili, in cemento, peso kg 50

*Concrete ballast cube for portable basketball backstop, weight 50 kg*

4

## Impianti minibasket Mini-basket backstops

S04150



### S04150

Impianto minibasket a muro su struttura regolabile in altezza, tabelloni in polipropilene, canestri fissi e retine  
*Wall mounted mini-basket backstops on height adjustable construction, polypropylene backboards, fixed rings with nets*

S04151



### S04151

Impianto minibasket a muro, sbalzo cm 80 su singolo tubolare di acciaio verniciato, tabelloni in nobilitato bilaminato, canestri fissi e retine  
*Wall mounted mini-basket backstops on single 80 cm projection arm in varnished steel, chipboard backboards, fixed rings and nets*

S04152



### S04152

Impianto minibasket a muro, struttura in acciaio verniciato, con sbalzo cm 185, tabelloni di nobilitato bilaminato, canestri fissi e retine  
*Wall mounted mini-basket backstops, varnished steel structure units, projection 185 cm, chipboard backboards, fixed rings and nets*



S04154

### S04154

Impianto minibasket a traliccio di acciaio zincato, sbalzo cm 145, tabelloni di resina melamminica, canestri fissi e retine  
*Galvanized steel mini-basket backstops, projection 145 cm, hpl backboards, fixed rings and nets*



S04156 - ZOOM

### S04156

Impianto minibasket a traliccio di acciaio zincato mobile con carrello su ruote, sbalzo cm 145, cassoni porta zavorra, tabelloni di resina melamminica, canestri fissi e retine  
*Galvanized steel mini-basket backstops mobile with trolley, with ballast boxes, projection 145 cm, hpl backboards, fixed rings and nets*



S04158

### S04158

Coppia protezioni frontali per impianto minibasket a traliccio S04154 e S04156  
*Pair of front protection pads for mini-basket backstops S04154 and S04156*

## NOTE

Tutti gli impianti minibasket presenti in questa sezione sono forniti con canestri S04230.

All mini-basket backstops included in this section are supplied with rings S04230.



## S04159

Impianto minibasket monotubolare di acciaio zincato, sbalzo cm 165, tabelloni di resina melamminica, canestri fissi e retine  
*Galvanized steel monotubular mini-basket backstops, projection 165 cm, hpl backboards, fixed rings and nets*

## S04160

Coppia protezioni frontali per impianto minibasket monotubolare S04159  
*Pair of front protection pads for monotubular mini-basket backstops S04159*



## S04161

Coppia strutture minibasket in acciaio verniciato agganciabili a tabellone basket, complete di tabellone in nobilitato bilaminato, canestro fisso e retina

*Pair of mini-basket varnished steel constructions to be attached to basketball backboard, including chipboard backboards, fixed rings and nets*

## S04162

Carrello in acciaio verniciato, mobile su ruote, per sollevamento strutture minibasket agganciabili S04161

*Varnished steel trolley, mobile on wheels, lifting the mini-basket constructions S04161*

5

## Tabelloni basket e minibasket, protezioni, canestri, retine

### Basket and mini-basket backboards, protective pads, rings, nets



S04202 - S04204

**S04202**

Tabellone basket di nobilitato bilaminato per interno, dimensioni mm 1800x1050x18

*Chipboard basketball backboard for indoor use, dimensions 1800x1050x18 mm*

**S04204**

Tabellone basket di resina melamminica per esterno, dimensioni mm 1800x1050x10

*Hpl basketball backboard for outdoor use, dimensions 1800x1050x10 mm*

**S04205**

Tabellone basket di vetroresina con anima in legno per uso interno ed esterno, dimensioni mm 1800x1050x30

*Wooden core fibreglass covered basketball backboard for indoor and outdoor use, dimensions 1800x1050x30 mm*

**S04206**

Tabellone basket di plexiglas trasparente, dimensioni mm 1800x1050x15 con risega, su telaio in acciaio verniciato con protezione S04222

*Transparent acrylic glass basketball backboard, dimensions 1800x1050x15 mm with ring cutout, mounted onto varnished steel frame with pad S04222*

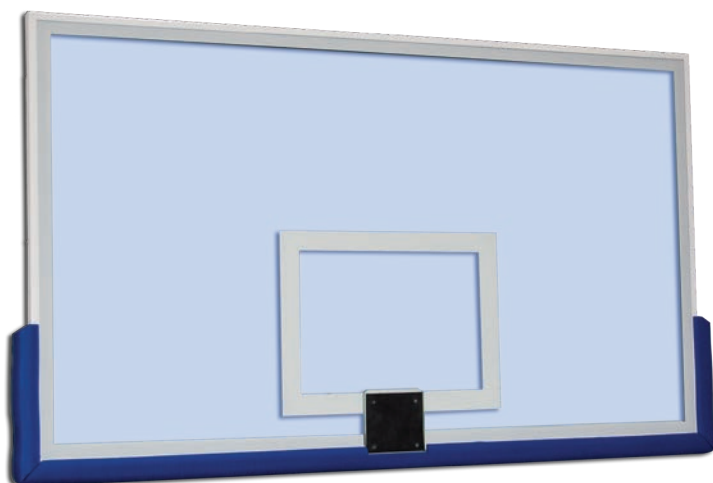

S04206 - S04208

**S04208**

Tabellone basket di cristallo temperato con pellicola di sicurezza, dimensioni mm 1800x1050x12 con risega, su telaio in acciaio verniciato con protezione S04222

*Safety tempered glass basketball backboard with protective film, dimensions 1800x1050x12 mm with ring cutout, mounted onto varnished steel frame with pad S04222*

**S04210**

Tabellone basket di cristallo temperato con pellicola di sicurezza, dimensioni mm 1800x1050x12 con risega, su telaio in acciaio verniciato con protezione S04224

*Safety tempered glass basketball backboard with protective film, dimensions 1800x1050x12 mm with ring cutout, mounted onto varnished steel frame with pad S04224*



S04214 - S04216

**S04214**

Tabellone minibasket di nobilitato bilaminato per interno, dimensioni mm 1200x900x18

*Chipboard mini-basket backboard for indoor use, dimensions 1200x900x18 mm*

**S04216**

Tabellone minibasket di resina melamminica per esterno, dimensioni mm 1200x900x10

*Hpl mini-basket backboard for outdoor use, dimensions 1200x900x10 mm*

**S04218**

Telaio di acciaio verniciato per supporto tabellone basket  
*Varnished steel frame supporting basketball backboard*

**S04220**

Telaio di acciaio verniciato per supporto tabellone minibasket  
*Varnished steel frame supporting mini-basket backboard*

S04221

**S04221**

Carrello in acciaio verniciato funzionale allo stoccaggio, alla movimentazione ed all'installazione di tabelloni su impianti basket mobili su ruote  
*Varnished steel trolley useful to storage, transport and install backboard on portable basketball backstops*

S04226



S04222

**S04222**

Protezione di poliuretano da applicare con viti su telaio tabellone basket, modello ad L  
*Polyurethane basketball backboard pad to be fixed with screws, L shaped model*

**S04224**

Protezione di poliuretano da applicare con viti su telaio tabellone basket, modello ad U secondo norme FIBA  
*Polyurethane basketball backboard pad to be fixed with screws, U shaped model accordingly to FIBA rules*

**S04226**

Per-Light, cornice luminosa a led di colore rosso più segmento a led di colore giallo da applicare sul tabellone basket in cristallo, con centralina di comando per collegamento ad indicatore 24"  
*Per-Light, set of red led perimeter plus yellow led segment to be installed on glass basketball backboard, complete of control unit for connection to 24" shot clock*

Le protezioni di poliuretano **S04224** sono disponibili in colore **blu**, **nero** e **rosso**; per ordini di minimo 50 pezzi possono essere prodotte in qualsiasi altro colore, a richiesta.

**NOTE**

*Polyurethane pads **S04224** are available in **blue**, **black** and **red** colors; for orders of minimum 50 pieces can be produced of any other different color, on demand.*

**S04228**

Canestro regolamentare in acciaio verniciato  
*Standard varnished steel basketball ring*

**S04230****NEW**

Canestro regolamentare in acciaio verniciato, modello pesante  
*Standard varnished steel basketball ring, heavy model*

**S04232**

✓ EN1270 tested

Canestro regolamentare super rinforzato in acciaio verniciato a norma EN1270  
*Standard varnished steel basketball ring, heavy reinforced model according to EN1270*

**S04234**

✓ EN1270 tested

Canestro regolamentare reclinabile in acciaio verniciato a norma EN1270  
*Reclining varnished steel basketball ring according to EN1270*

**S04235**

Canestro regolamentare reclinabile in acciaio zincato a norma EN1270  
*Reclining galvanized steel basketball ring according to EN1270*

**S04236**

✓ EN1270 tested

Canestro regolamentare reclinabile in tubo pieno di acciaio verniciato a norma EN1270, fissaggio retina senza ganci  
*Reclining varnished steel basketball ring, reinforced model according to EN1270, net fixation without hooks*

**S04237**

✓ EN1270 tested

Canestro regolamentare reclinabile in 3 direzioni (anche lateralmente) in tubo pieno di acciaio verniciato a norma EN1270, fissaggio retina senza ganci  
*Three directions reclining varnished steel basketball ring, reinforced model according to EN1270, net fixation without hooks*

**S04238**

Canestro regolamentare in acciaio zincato per esterno  
*Standard galvanized steel basketball ring for outdoor use*

**S04240**

Retina basket regolamentare di nylon  
*Nylon cord basketball net*

**S04241**

Retina basket regolamentare di nylon plastificato, anti-attorcigliamento  
*Plastified nylon cord basketball net, anti-whip*

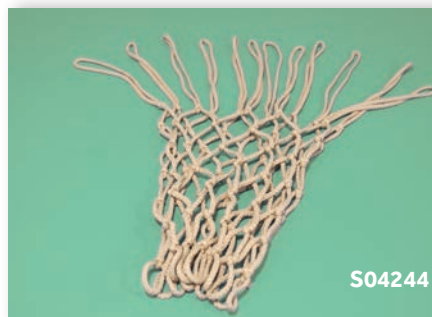
**S04244**

Retina basket regolamentare di cotone  
*Cotton cord basketball net*

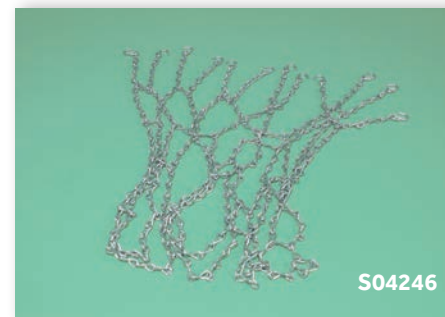
**S04246**

Retina basket di acciaio zincato per esterno  
*Galvanized steel basketball net for outdoor use*

## NOTE



winner of  
Women's Club World Champs  
CEU Women's Champions League  
Women's Club Italian Champs



**Fornitore ufficiale - Official supplier: Imoco Volley Conegliano - serie A1**



## NOTE

### Sedute vip "Sport System by Lino Sonego" per riserve ed allenatori

Un tocco di stile italiano a bordo campo!

In alternativa alle più tradizionali panchine per le riserve e gli allenatori Sport System offre, anche per i palazzetti multi sport indoor, la possibilità di attrezzare le aree tecniche delle due squadre con poltrone VIP totalmente personalizzabili nella scelta del modello, dei colori e dell'eventuale logo da ricamare.

Per maggiori informazioni e per richiedere un preventivo contattare [info@sportssystem.it](mailto:info@sportssystem.it)

### VIP armchairs "Sport System by Lino Sonego" for substitute players and coaches

A touch of Italian style on courtside!

As an alternative to the traditional substitute benches Sport System offers, even for indoor multi sport arenas, the option of upgrading both two teams' technical areas with luxury VIP armchairs. These can be customized with any colours and logos. The logos are permanently embroidered.

For further information or samples contact [info@sportssystem.it](mailto:info@sportssystem.it)





6

**Panchine per giocatori, tavoli giuria, accessori**  
**Players benches, judges tables, accessories**



S04252

**S04252**

Poltrona per riserve ed allenatori in pelle sintetica su supporto mobile in acciaio verniciato. Disponibile in vari modelli. Personalizzabile nei colori e con ricamo loghi (vedi pagina 86)

*High comfort luxury armchair for players and coach covered by synthetic leather to be customized with colours and logos, mounted onto steel support. Available in different models (refer to page 86)*

S04254

**S04254**

Panca per riserve ed allenatori con poggiaschiena, struttura di acciaio verniciato, doghe di legno, lunghezza cm 300

*Players and coach bench with backrest, varnished steel structure, wooden seating area, length 300 cm*



S04256

**S04256**

Tavolo per giuria con struttura di acciaio verniciato e piano di legno, dimensioni cm 160x80x76

*Judges table with varnished steel structure and wooden top, dimensions 160x80x76 cm*



S04260

**S04260**

Tavolo per giuria con struttura di acciaio verniciato e carenatura di legno, dimensioni cm 300x70x76, mobile su ruote

*Judges table with varnished steel structure, wooden top and sides, dimensions 300x70x76 cm, mobile on wheels*



S04263

**S04263**

Imbottitura per tavolo giuria mt 3, S04260 e S04262

*Soft pad for judges table with length of 3 mt, S04260 and S04262*



S04262

**S04262**

Tavolo per giuria con struttura di acciaio verniciato e carenatura di legno, pedana ribaltabile per contenimento oggetti, dimensioni cm 300x70x76, mobile su ruote

*Judges table with varnished steel structure, wooden top and sides, closing platform for storing accessories, dimensions 300x70x76 cm, mobile on wheels*



S04264

**S04264**

Tavolo per giuria modello FIBA mobile su ruote, frontale imbottito e rivestito, completo di sgabelli cambio giocatori ai lati, dimensioni totali cm 515x95x90

*Judges table FIBA model mobile on wheels, padded and covered front panel, wooden top, including players substitution stools, total dimensions 515x95x90 cm*



S04266

**S04266**

Protezione mobile su ruote per tavolo giuria e panche per riserve ed allenatori, struttura in acciaio verniciato, pannellatura in policarbonato trasparente  
*Protective screen for judges table or players and coach benches, varnished steel structure and transparent polycarbonate panel, mobile on wheels*



S04268

**S04268**

Sedia per giudici in polipropilene colorato con struttura di acciaio cromato  
*Judge chair made of coloured polypropylene with chromed steel structure*



S04270

**S04270**

Sgabello di legno per cambio giocatori  
*Wooden stool for player substitution*

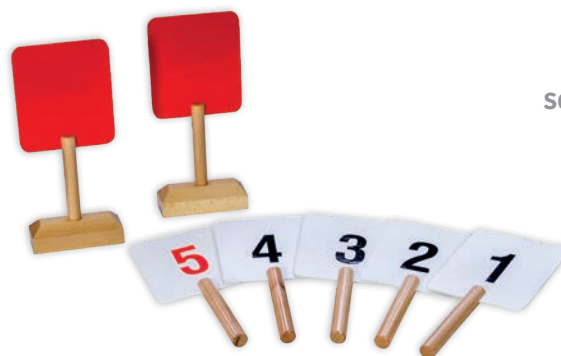

S04272

**S04272**

Serie palette in legno per indicazione manuale dei falli di squadra, compresi supporti  
*Set of wooden plates with supports for manual indication of teams' fouls*



S04274

**S04274**

Serie palette in legno per indicazione manuale dei 24 secondi  
*Set of wooden plates for manual indication of 24 seconds*

**S04276**

Cronometro contasecondi per tavolo giudici  
*Stopwatch chronometer for judges table*

**S04277**

Cronometro contasecondi per tavolo giudici, digitale  
*Digital stopwatch chronometer for judges table*

S04278

**S04278**

Segnapunti manuale da tavolo per basket  
*Portable desk manual scoreboard for basketball*



S04280

**S04280**

Segnapunti manuale a 6 cifre (3+3) su struttura girevole con base in acciaio verniciato

*Manual scoreboard with 6 digits (3+3) on revolving varnished steel structure with base*

S04282

**S04282**

Segnapunti manuale a 6 cifre (3+3) su struttura in acciaio verniciato da fissare a parete

*Manual scoreboard with 6 digits (3+3) on varnished steel frame to be fixed to the wall*

S04284

**S04284**

Tabella di ricambio per segnapunti manuale, colore rosso o nero

*Replacement digit panel for manual scoreboard, red or black colour*

S04286

**S04286**

Lavagna magnetica per basket con pedine, dimensioni cm 85x60

*Magnetic tactic board for basketball, dimensions 85x60 cm*



S04288

**S04288**

Dispositivo manuale di indicazione possesso palla

*Manual alternating possession arrow*



S04290

**S04290**

Dispositivo elettronico di indicazione possesso palla, secondo disposizioni FIBA, dimensioni cm 60x25x5

*Electronic alternating possession arrow, in accordance with FIBA rules, dimensions 60x25x5 cm*

S04292

**S04292**

Misuratore di alluminio per verifica altezza canestro

*Aluminium height measurer device for ring's height*

## Articoli allenamento basket Training accessories for basket

### S04293

Macchina spara palloni Dr Dish  
modello Rebel (livello base)  
*Dr Dish balls shooting machine for  
basket, model Rebel (entry level)*

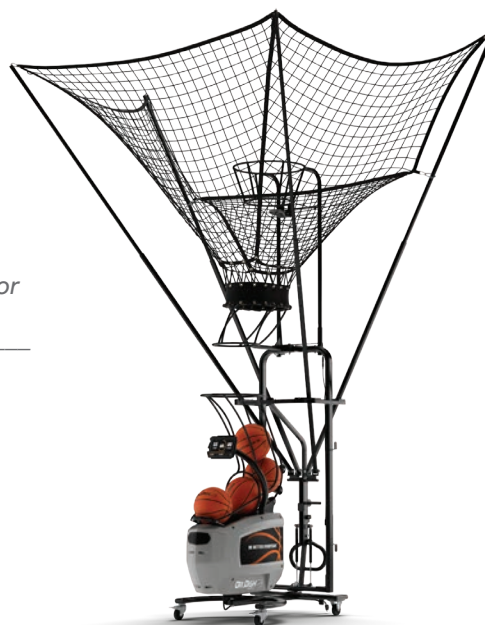

### S04294

Macchina spara palloni Dr Dish  
modello All Star (livello medio)  
*Dr Dish balls shooting machine for  
basket, model All Star (medium level)*

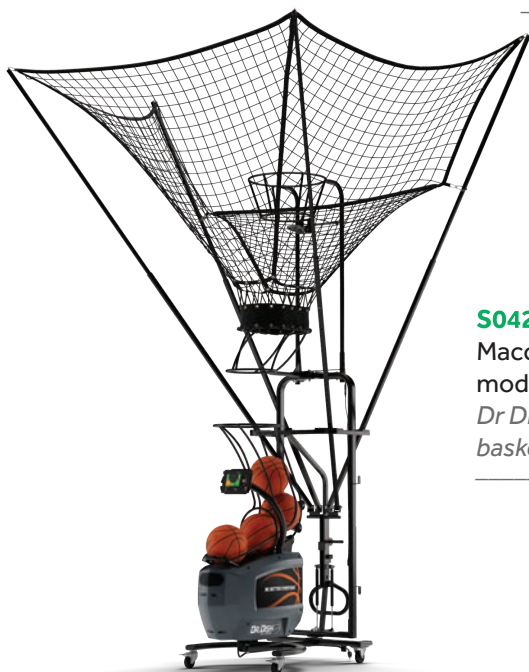

### S04295

Macchina spara palloni Dr Dish  
modello CT (livello top)  
*Dr Dish balls shooting machine for  
basket, model CT (top level)*



### S04296

Raccoglitore di palloni Dr Dish IC3 applicabile a  
qualsiasi impianto basket  
*Dr Dish IC3 shot trainer rebounder suitable for all  
different models of basketball backstop*

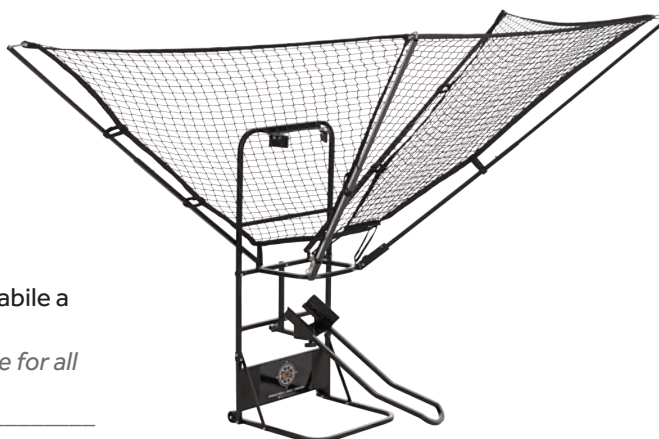

**S04297**

Sagoma in posizione difensiva per allenamento gioco basket con base auto stabile

*Portable hands-up mannequin for basket with self-standing base*

**S04298**

Dribble Stick SKLZ funzionale a diverse sessioni di allenamento con la palla

*Dribble stick SKLZ suitable for several different training exercises with ball*

**S04299**

Telaio con rete Solo Assist per simulazione assist ed allenamento al passaggio

*Solo Assist rebounder frame suitable for training on assist and catching the ball*

8

## Porte calcio e calcio ridotto, accessori Standard and reduced soccer goals, accessories



S04302

**S04302** ✓ EN748 tested

Coppia porte calcio regolamentari in alluminio, sezione ovale mm 120x100, modello a bussole con pali reggirete distanziati, traversa divisa

*Pair of aluminium standard soccer goals, oval section 120x100 mm, ground sockets to be buried and free hanging net supports, crossbar in two sections*



S04306

**S04306** ✓ EN748 tested

Coppia porte calcio regolamentari in alluminio, sezione ovale mm 120x100, modello mobile con base, traversa divisa

*Pair of aluminium standard soccer goals, oval section 120x100 mm, portable freestanding model with ground base, crossbar in two sections*



S04303

**S04303** ✓ EN748 tested

Coppia porte calcio regolamentari in alluminio, sezione ovale mm 120x100, modello a bussole con reggirete a gomito, traversa divisa

*Pair of aluminium standard soccer goals, oval section 120x100 mm, ground sockets to be buried and curved net supports, crossbar in two sections*



S04307

**S04307** ✓ EN748 tested

Coppia porte calcio regolamentari in alluminio, modello mobile con base, interamente realizzate con profilo a sezione ovale mm 120x100, traversa divisa

*Pair of aluminium standard soccer goals, portable freestanding model with ground base, entirely realized with oval section profiles 120x100 mm, crossbar in two section*

**S04304** ✓ EN748 tested

Coppia porte calcio come articolo S04302 - traversa intera

*Pair of aluminium standard soccer goals as S04302 - entire crossbar*

**S04308** ✓ EN748 tested

Coppia porte calcio come articolo S04306 - traversa intera

*Pair of aluminium standard soccer goals as S04306 - entire crossbar*

**S04305** ✓ EN748 tested

Coppia porte calcio come articolo S04303 - traversa intera

*Pair of aluminium standard soccer goals as S04303 - entire crossbar*

**S04309** ✓ EN748 tested

Coppia porte calcio come articolo S04307 - traversa intera

*Pair of aluminium standard soccer goals as S04307 - entire crossbar*



**S04310** ✓ EN16579 tested

Coppia porte calcio a 7 in alluminio, dimensioni cm 600x200, sezione ovale mm 120x100, modello mobile con base  
*Pair of aluminium goals for 7 a side soccer, dimensions 600x200 cm, oval section 120x100 mm, portable freestanding model with ground base*

**S04311**

Coppia porte calcio a 7 in alluminio, dimensioni cm 600x200, sezione ovale mm 120x100, modello a bussole con reggirete a gomito  
*Pair of aluminium goals for 7 a side soccer, dimensions 600x200 cm, oval section 120x100 mm, ground sockets model with curved net supports*

**S04312**

Coppia porte calcio a 7 in alluminio, dimensioni cm 600x200, sezione mm 80, modello mobile con base  
*Pair of aluminium goals for 7 a side soccer, dimensions 600x200 cm, round section diameter 80 mm, portable freestanding model with ground base*

**S04314**

Coppia porte calcio a 7 in acciaio, dimensioni cm 600x200, sezione mm 80, modello mobile con base  
*Pair of steel goals for 7 a side soccer, dimensions 600x200 cm, round section diameter 80 mm, portable freestanding model with ground base*

**S04316** ✓ EN748 tested

Coppia porte calcio ridotto in alluminio, dimensioni cm 500x200, sezione ovale mm 120x100, modello mobile con base  
*Pair of aluminium reduced goals for soccer, dimensions 500x200 cm, oval section 120x100 mm, portable freestanding model with ground base*

**S04317** ✓ EN748 tested

Coppia porte calcio ridotto in alluminio, dimensioni cm 500x200, sezione ovale mm 120x100, modello a bussole con reggirete a gomito  
*Pair of aluminium reduced goals for soccer, dimensions 500x200 cm, oval section 120x100 mm, ground sockets model with curved net supports*

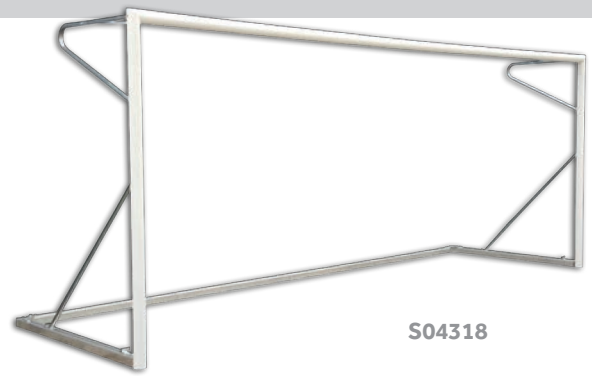

**S04318** ✓ EN16579 tested

Coppia porte calcio ridotto in alluminio, dimensioni cm 500x200, sezione mm 80, modello mobile con base  
*Pair of aluminium reduced goals for soccer, dimensions 500x200 cm, round section diameter 80 mm, portable freestanding model with ground base*



**S04320** ✓ EN748 tested

Coppia porte calcio ridotto in acciaio, dimensioni cm 500x200, sezione mm 80, modello mobile con base  
*Pair of steel reduced goals for soccer, dimensions 500x200 cm, round section diameter 80 mm, portable freestanding model with ground base*

**S04322** ✓ EN16579 tested

Coppia porte calcio ridotto in alluminio, dimensioni cm 400x200, sezione ovale mm 120x100, modello mobile con base  
*Pair of aluminium reduced goals for soccer, dimensions 400x200 cm, oval section 120x100 mm, portable freestanding model with ground base*

**S04323** ✓ EN16579 tested

Coppia porte calcio ridotto in alluminio, dimensioni cm 400x200, sezione ovale mm 120x100, modello a bussole con reggirete a gomito  
*Pair of aluminium reduced goals for soccer, dimensions 400x200 cm, oval section 120x100 mm, ground sockets model with curved net supports*

**S04324** ✓ EN16579 tested

Coppia porte calcio ridotto in alluminio, dimensioni cm 400x200, sezione mm 80, modello mobile con base  
*Pair of aluminium reduced goals for soccer, dimensions 400x200 cm, round section diameter 80 mm, portable freestanding model with ground base*



**S04326**

Coppia porte calcio ridotto in acciaio, dimensioni cm 400x200, sezione mm 80, modello mobile con base  
*Pair of steel reduced goals for soccer, dimensions 400x200 cm, round section diameter 80 mm, portable freestanding model with ground base*

**S04328**

Coppia telai fissi a terra, in acciaio zincato, per porte calcio regolamentari a bussole  
*Pair of fixed ground frames made of galvanized steel, for standard soccer goals, sockets type*

**S04330**

Coppia dispositivi alza rete, in acciaio zincato, per porte calcio regolamentari a bussole  
*Pair of foldable ground frames made of galvanized steel for standard soccer goals, sockets type*

**S04331**

Coppia dispositivi alza rete in alluminio con gancetti reggirete in polipropilene, per porte calcio regolamentari a bussole  
*Pair of foldable ground frames in aluminium with plastic safety net holders for standard soccer goals, sockets type*

**S04332**

Coppia ruote gommate con staffa in acciaio per spostamento porte calcio mobili  
*Pair of rubber inflatable wheels on steel support useful for rolling away portable soccer goals*

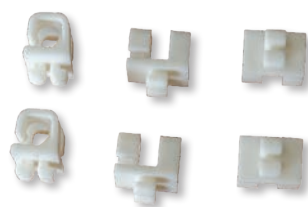
**S04335**

Serie 100 gancetti reggirete in polipropilene con doppio gancio per porte calcio, bloccaggio a pressione  
*Set of 100 plastic safety net holders with twin hooks for soccer goal, blocking by pressure*

**S04336**

Serie 100 gancetti reggirete in polipropilene per porte calcio, bloccaggio a pressione  
*Set of 100 plastic safety net holders for soccer goal, blocking by pressure*

**S04340**

Modulo zavorra per porte calcio, calcio ridotto, pallamano e calcetto composto di due profili in alluminio zavorrabili uniti tra loro  
*Ballast module for football, reduced football, handball and futsal goals made up of two aluminum profiles joined together, to be filled*

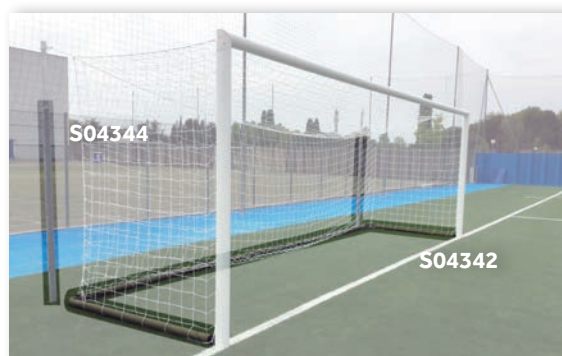
**S04342**

Set protezioni per coppia telai a terra fissi (S04328) o ribaltabili (S04330, S04331) composti di elementi soffici e rivestimento in PVC  
*Set of protection pads for the pair of fixed (S04328) or folding (S04330, S04331) ground frames made of soft elements and PVC covers*

**S04344**

Set protezioni per i 4 pali distanziati posteriori tendi rete per porte calcio a bussole (S04302, S04304) composti di elementi soffici e rivestimento in PVC  
*Set of protection pads for the 4 rear poles useful for tensioning the net on socket type goals (S04302, S04304) made of soft elements and PVC covers*

## Reti per porte calcio e calcio ridotto

### Nets for standard and reduced soccer goals

**S04352**

Coppia reti calcio regolamentari in polietilene diametro mm 3, profondità cm 100/200, maglia cm 12x12 con nodo

*Pair of nets for standard soccer goals made of polyethylene diameter 3 mm, depth 100/200 cm, knotted mesh 12x12 cm*

**S04354**

Coppia reti calcio regolamentari in polipropilene diametro mm 5, profondità cm 100/200, maglia esagonale

*Pair of nets for standard soccer goals made of polypropylene diameter 5 mm, depth 100/200 cm, hexagonal mesh*

**S04356**

Coppia reti calcio regolamentari in polipropilene diametro mm 6, profondità cm 100/200, maglia cm 10x10 senza nodo

*Pair of nets for standard soccer goals made of polypropylene diameter 6 mm, depth 100/200 cm, knotless mesh 10x10 cm*

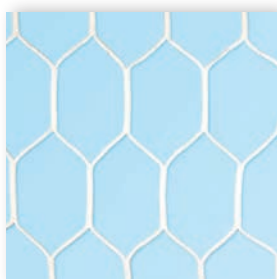
**S04358**

Coppia reti calcio regolamentari in nylon diametro mm 6, profondità cm 100/200, maglia esagonale

*Pair of nets for standard soccer goals made of nylon diameter 6 mm, depth 100/200 cm, hexagonal mesh*

**S04360**

Coppia reti calcio regolamentari in polietilene diametro mm 3,5 annodato, profondità cm 200/200, maglia quadra

*Pair of nets for standard soccer goals made of polyethylene diameter 3.5 mm knotted, depth 200/200 cm, square mesh*

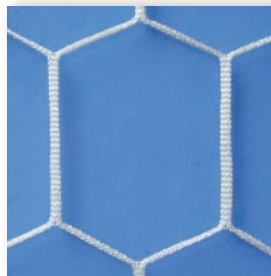
**S04362**

Coppia reti calcio regolamentari in polipropilene diametro mm 4, profondità cm 200/200, maglia esagonale

*Pair of nets for standard soccer goals made of polypropylene diameter 4 mm, depth 200/200 cm, hexagonal mesh*

**S04364**

Coppia reti calcio regolamentari in nylon diametro mm 5, profondità cm 200/200, maglia cm 10x10, disponibili in vari colori

*Pair of nets for standard soccer goals made of nylon diameter 5 mm, depth 200/200 cm, mesh 10x10 cm, available in several colors*

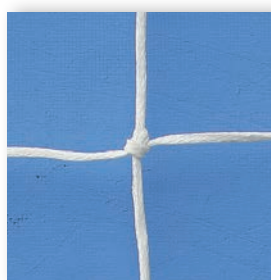
**S04366**

Coppia reti calcio ridotto cm 600x200 in polietilene diametro mm 3,5 con nodo, profondità cm 100/160, maglia cm 14x14

*Pair of nets for reduced soccer goals 600x200 cm made of polyethylene diameter 3.5 mm knotted, depth 100/160 cm, square mesh 14x14 cm*

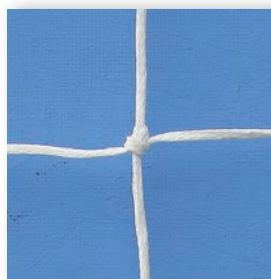
**S04368**

Coppia reti calcio ridotto cm 500x200 in polietilene diametro mm 3,5 con nodo, profondità cm 100/160, maglia cm 14x14

*Pair of nets for reduced soccer goals 500x200 cm made of polyethylene diameter 3.5 mm knotted, depth 100/160 cm, square mesh 14x14 cm*

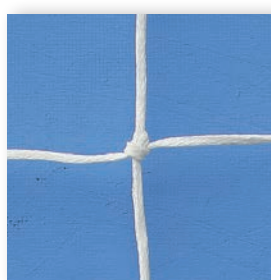
**S04370**

Coppia reti calcio ridotto cm 400x200 in polietilene diametro mm 3,5 con nodo, profondità cm 100/160, maglia cm 14x14

*Pair of nets for reduced soccer goals 400x200 cm made of polyethylene diameter 3.5 mm knotted, depth 100/160 cm, square mesh 14x14 cm*

10

## Panchine per riserve ed allenatori Team shelters



### S04402

Panchina riserve e allenatori, struttura di acciaio zincato, pannelli di stratificato e policarbonato alveolare mm 6, sedute a doghe di legno o scocche di polipropilene

*Team shelter, galvanized steel construction, hollow cell polycarbonate panels 6 mm, continuous wooden bench or polypropylene seats*



### S04408

Panchina riserve e allenatori, struttura di alluminio, pannelli di stratificato e policarbonato alveolare mm 6, sedute a doghe di legno o scocche di polipropilene

*Team shelter, aluminium construction, hollow cell polycarbonate panels 6 mm, continuous wooden bench or polypropylene seats*



### S04404

Panchina riserve e allenatori, struttura di acciaio zincato, pannelli di stratificato e policarbonato trasparente mm 3, sedute a doghe di legno o scocche di polipropilene

*Team shelter, galvanized steel construction, transparent polycarbonate panels 3 mm, continuous wooden bench or polypropylene seats*

### S04406

Coppia elementi laterali per panchina riserve e allenatori in acciaio zincato S04402 e S04404, pannelli di stratificato e policarbonato trasparente mm 3

*Pair of lateral elements for galvanized steel team shelters S04402 and S04404 with transparent polycarbonate panels*



### S04410

Panchina riserve e allenatori, struttura di alluminio, pannelli di stratificato e policarbonato trasparente mm 3, sedute a doghe di legno o scocche di polipropilene

*Team shelter, aluminium construction, transparent polycarbonate panels 3 mm, continuous wooden bench or polypropylene seats*

### S04412

Coppia elementi laterali per panchina riserve e allenatori in alluminio S04408 e S04410, pannelli di stratificato e policarbonato trasparente mm 3

*Pair of lateral elements for aluminium team shelters S04408 and S04410 with transparent polycarbonate panels*



S04414 + S04416

**S04414**

Panchina riserve e allenatori, struttura di acciaio zincato, pannelli di polycarbonato trasparente mm 3, sedute a scocche di polipropilene, protezione parasigoli  
*Team shelter, galvanized steel construction, transparent polycarbonate panels 3 mm, polypropylene seats, soft corners protection pad*

**S04418**

Panchina riserve e allenatori a doppia profondità, struttura di acciaio zincato, pannelli di polycarbonato trasparente mm 3, modulo da mt 2 completo di tribunetta di seduta in acciaio zincato a 2 gradoni con 7 scocche di seduta di polipropilene, protezione parasigoli  
*Double depth team shelter, galvanized steel construction, transparent polycarbonate panels 3 mm, module of 2 mt complete of 2 steps galvanized steel stand with 7 polypropylene seats, soft corners protection pad*

**S04420**

Coppia elementi laterali per panchina riserve e allenatori a doppia profondità in acciaio zincato S04418, pannelli di polycarbonato trasparente mm 3  
*Pair of lateral elements for double depth galvanized steel team shelters S04418 with transparent polycarbonate panels*



S04415 + S04416

**S04415**

Panchina riserve ed allenatori S04414 su struttura mobile con ruote  
*Team shelter S04414 on structure mobile with wheels*

**S04416**

Coppia elementi laterali per panchine riserve e allenatori in acciaio zincato S04414 e S04415, pannelli di polycarbonato trasparente mm 3  
*Pair of lateral elements for galvanized steel team shelters S04414 and S04415 with transparent polycarbonate panels*



S04418 + S04420



S04422 + S04424

**S04422**

Panchina riserve e allenatori ad altezza ridotta (cm 165), struttura di acciaio zincato, pannelli di polycarbonato trasparente mm 3, sedute a scocche di polipropilene, protezione parasigoli  
*Reduced height team shelter (165 cm), galvanized steel construction, transparent polycarbonate panels 3 mm, polypropylene seats, soft corners protection pad*

**S04424**

Coppia elementi laterali per panchina riserve e allenatori ad altezza ridotta in acciaio zincato S04422, pannelli di polycarbonato trasparente mm 3  
*Pair of lateral elements for reduced height galvanized steel team shelters S04422 with transparent polycarbonate panels*



S04426 + S04428

**S04426**

Panchina riserve e allenatori trasportabile, copertura con struttura di alluminio e pannelli di stratificato e policarbonato trasparente mm 3, pedana in acciaio zincato con superficie di alluminio e ruote girevoli integrate sul fondo, sedute a scocche di polipropilene su struttura in acciaio zincato collegata alla pedana

*Portable team shelter, cover construction made of aluminium with hpl and transparent polycarbonate panels 3 mm, galvanized steel platform with aluminium surface and pivoting wheels installed on bottom side, polypropylene seats on galvanized steel structure fixed to the platform*



S04426 + S04428

S04427 + S04428

**S04427**

Panchina riserve ed allenatori S04410 su struttura mobile con ruote

*Team shelter S04410 on structure mobile with wheels*

**S04428**

Coppia elementi laterali per panchine riserve e allenatori trasportabili S04426 e S04427, struttura in alluminio con pannelli di stratificato e policarbonato trasparente mm 3

*Pair of lateral elements for portable team shelters S04426 and S04427, aluminium construction with hpl and transparent polycarbonate panels*



S04430

**S04430**

Panchina riserve e allenatori a buca completa di elementi laterali, struttura di acciaio zincato realizzata a disegno, pannelli di policarbonato trasparente mm 3, sedute di polipropilene colorato, protezioni parasigoli

*Team shelter with lateral elements to be customized over existing pit, galvanized steel structure, transparent polycarbonate panels 3 mm, polypropylene seats, soft corners protection pads*



S04432

**S04432**

Protezione parasigoli per panchine riserve e allenatori di gomma ad alta densità rivestita di materiale sintetico, applicabile con Velcro

*Corner protection pad for team shelter, high density foam covered outside by synthetic material, applicable with Velcro*

**S04434**

Modulo di seduta per panchina quarto uomo composto di due scocche in polipropilene colorato con leggio ribaltabile e piano porta borse su struttura in acciaio zincato

*Seating element for soccer referees made of 2 polypropylene seats with tip-up writing boards and bags support table*



S04434

## LINEA VIP - VIP LINE

S04439

**S04439**

Panchina riserve ed allenatori S04440 su struttura mobile con ruote

*Team shelter S04440 on structure mobile with wheels*



S04440

**S04440**

Panchina riserve e allenatori completa di elementi laterali, struttura di alluminio, pannelli di stratificato e policarbonato trasparente mm 3, poltrone in ecopelle personalizzabili, protezioni parasigoli

*Team shelter with lateral elements, aluminium construction, transparent polycarbonate panels 3 mm, high comfort padded armchairs to be customized, soft corner protection pads*

**NOTE**

Le panchine della presente **linea VIP** sono totalmente personalizzabili dal punto di vista funzionale ed estetico in base alle esigenze del cliente e possono essere fornite con oltre 10 diversi modelli di poltrone VIP.

*Team shelters of **VIP line** can be totally customized under the functional and aesthetic points of view based on customer's requirements and can be supplied with over 10 different models of VIP armchairs.*



S04441

**S04441**

Panchina riserve ed allenatori S04442 su struttura mobile con ruote.

*Team shelter S04442 on structure mobile with wheels*



S04442

**S04442**

Panchina riserve e allenatori completa di elementi laterali, struttura di acciaio zincato, pannelli di policarbonato trasparente mm 3, poltrone in ecopelle personalizzabili, protezione parasigoli

*Team shelter with lateral elements, galvanized steel construction, transparent polycarbonate panels 3 mm, high comfort padded armchairs to be customized, soft corner protection pad*



S04444

**S04444**

Panchina riserve e allenatori completa di elementi laterali, struttura di acciaio zincato e verniciato, pannelli di policarbonato ombreggiato mm 3, pedana in acciaio zincato con superficie di alluminio e ruote girevoli integrate sul fondo, poltrone in ecopelle personalizzabili, protezione parasigoli

*Team shelter with lateral elements, galvanized and epoxy painted steel construction, grey polycarbonate panels 3 mm, galvanized steel platform with aluminium surface and pivoting wheels installed on bottom side, high comfort padded armchairs to be customized, soft corner protection pad*

**S04445**

Panchina riserve e allenatori modello "Marrakech", copertura in acciaio zincato con pannelli di policarbonato trasparente mm 3, completa di elementi laterali, su pedana in acciaio zincato con superficie di alluminio e ruote girevoli integrate sul fondo, poltrone in ecopelle personalizzabili, protezione parasigoli. Altezza totale contenuta in soli cm 165

*Team shelter model "Marrakech", protective shell made in galvanized steel with transparent polycarbonate panels 3 mm, including lateral elements, mobile on galvanized steel platform with aluminium surface and pivoting wheels on bottom side, high comfort padded armchairs to be customized, soft corner protection pad. Total height reduced to a max of just 165 cm*



S04445

**S04449**

Display LED ad alta visibilità per uso esterno appositamente sagomato per installazione all'interno della protezione curva delle panchine VIP in acciaio zincato, in moduli da cm 200 facilmente gestibile con o senza PC. Utile per la trasmissione di messaggi informativi e promozionali

*High visibility LED display suitable for outdoor use, curved shape in order to be installed inside protective shell of team shelters galvanized steel, in modules of 200 cm easily operating with or without PC. Useful to provide information, promote sponsors and advertise*



S04449

**NOTE**

**Esempi di personalizzazione delle panchine della linea VIP: copertura a doppia profondità con 2 file di sedute e pedana di supporto della seconda fila (Slovenia); applicazione di pedana, con poggiatesta, mobile su ruote al modello S04442 (Sweden).**

*Examples of customization of VIP line's team shelters: double depth protective cover with seats in 2 lanes and supporting platform for the second lane (Slovenia); application of mobile footrest platform to model S04442 (Sweden).*



SLOVENIA

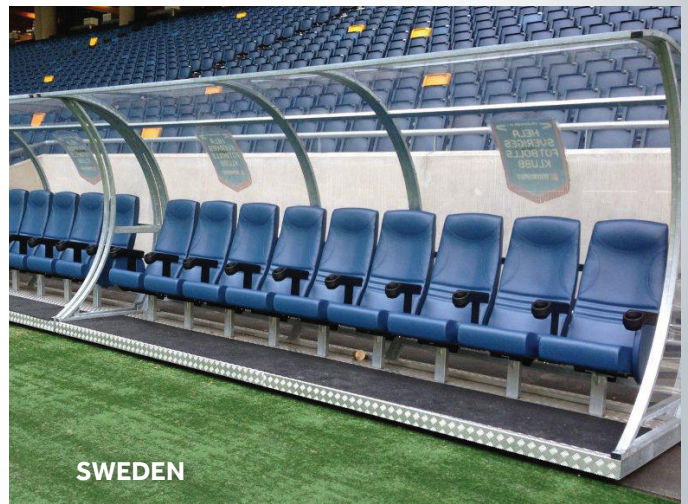

SWEDEN



## NOTE

**Panchine VIP per riserve ed allenatori. Stile ed eleganza a bordo campo!**

Da oltre 20 anni Sport System progetta e produce una linea completa di panchine VIP per riserve ed allenatori con strutture dal design differente e realizzate in acciaio zincato, acciaio zincato e verniciato o alluminio ... fisse a terra o mobili su ruote ... con poltrone "Sport System by Lino Sonego" di differenti modelli e personalizzabili nella scelta dei colori e nel ricamo di eventuali loghi ...  
Per maggiori informazioni e per richiedere un preventivo contattare [info@sportssystem.it](mailto:info@sportssystem.it)

**Luxury VIP team shelters. Style and elegance on courtside!**

For more than 20 years Sport System has been designing and manufacturing a complete line of VIP team shelters with different design structures made of galvanized steel, galvanized and varnished steel or aluminium ... ground fixed or portable on wheels ... equipped with armchairs "Sport System by Lino Sonego" available in different models that can be customized in different colours and by embroidering any logo ...  
For more info and to obtain a quote contact [info@sportssystem.it](mailto:info@sportssystem.it)

## REFERENZE

## REFERENCES

**Le panchine Sport System in prestigiosi stadi nazionali ed internazionali!**  
**Sport System's luxury team shelters in prestigious international football stadiums!**



LATVIA



RUSSIA



SLOVENIA



PANAMA

REFERENZE



BOSNIA AND HERZEGOVINA



RUSSIA



HUNGARY



MOROCCO

REFERENCES



ITALY



MOROCCO



CROATIA

11

## Accessori per arbitro Accessories for referee

**S04452**

Taccuino da taschino per arbitro completo di cartellini  
*Compact referee cards set for breast pocket*

**S04454**

Fischietto di acciaio con cordicella per arbitro  
*Metal whistle for referee with lanyard*

**S04456**

Bandierina per guardalinee con manico di plastica  
*Linesman's flag with plastic handle*

**S04458**

Drappo di ricambio di tela per bandierina guardalinee  
*Spare nylon flag for linesman's flag*

**S04460**

Segnalatore cambio giocatori manuale bifacciale "IN" e "OUT" a 2 cifre  
*Manual player substitution double face board "IN" and "OUT", 2 digits*

**S04462**

Segnalatore cambio giocatori manuale bifacciale "IN" e "OUT" a 2+2 cifre  
*Manual player substitution double face board "IN" and "OUT", 2+2 digits*

**S04465**

Dispositivo elettronico di segnalazione cambio giocatori monofacciale bicolore a 2+2 display  
*Electronic substitute indicator with 4 digits (2+2 of different colours), single face*

**S04467**

Dispositivo elettronico di segnalazione cambio giocatori bifacciale bicolore a 2+2 display  
*Electronic substitute indicator with 4 digits (2+2 of different colours), 2 faces*

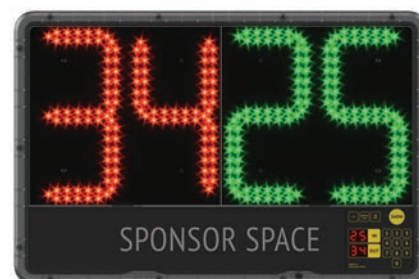
**S04469**

Valigetta per dispositivi S04465 e S04467  
*Carrying case for indicators S04465 and S04467*

**S04471**

Dispositivo elettronico S04467 completo di pannello sponsor superiore  
*Electronic substitute indicator S04467 with sponsor's space on top*



**Video dimostrativo disponibile al sito [www.sportssystem.it](http://www.sportssystem.it) nella sezione filmati.**

**Demonstrative video available at [www.sportssystem.it](http://www.sportssystem.it) in movies section.**

**S04473**

Valigetta per dispositivo S04471  
*Carrying case for indicator S04471*

## Articoli per allenamento gioco calcio Accessories for training



S04502

**S04502**

Arco regolabile in plastica flessibile per tiri di precisione

*Adjustable shape mini goal bow made of flexible plastic*



S04504

**S04504**

Coppia porte mini-calcio in plastica flessibile con reti, cm 150x110

*Pair of flexible plastic mini-soccer goals with nets, 150x110 cm*

**S04506**

Coppia porte mini-calcio in acciaio con reti, cm 150x110 (come S05132)

*Pair of varnished steel mini-soccer goals with nets, 150x110 cm (as S05132)*



S04507

**S04507**

Coppia porte mini-calcio professionali in acciaio con reti, cm 150x110, diametro mm 80

*Pair of professional varnished steel mini-soccer goals with nets, 150x110 cm, diameter 80 mm*

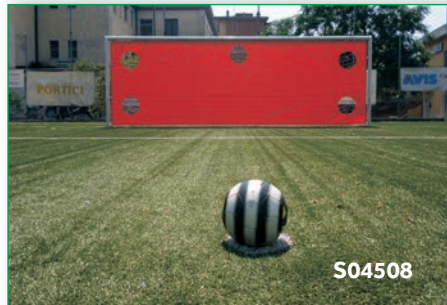

S04508

**S04508**

Telo di PVC per tiri di precisione da fissare alla porta calcio standard con dimensioni cm 732x244

*PVC banner for precision shot training to be fixed to standard soccer goals with dimensions 732x244 cm*

**S04510**

Telo di PVC per tiri di precisione da fissare alla porta calcio ridotto con dimensioni cm 600x200

*PVC banner for precision shot training to be fixed to reduced soccer goals with dimensions 600x200 cm*

**S04512**

Telo di PVC per tiri di precisione da fissare alla porta calcetto standard con dimensioni cm 300x200

*PVC banner for precision shot training to be fixed to standard futsal goals with dimensions 300x200 cm*



S04514

**S04514**

Ostacolo per allenamento di acciaio, graduabile in altezza a cm 30, 40, 50

*Training steel hurdle adjustable in height 30, 40, 50 cm*



S04516

**S04516**

Ostacolo per allenamento di acciaio, graduabile in altezza a cm 60, 70, 80, 90

*Training steel hurdle adjustable in height 60, 70, 80, 90 cm*

**S04518**

Set nr 6 ostacoli OVER in PVC con altezze cm 12, 20, 30, 40, 50, 60

*Set of nr 6 OVER hurdles in PVC with heights 12, 20, 30, 40, 50, 60 cm*



S04520

**S04520**

Ostacolo in PVC richiudibile con meccanismo a molla, altezze regolabili da cm 10 a cm 60

*PVC spring reclining hurdle adjustable in height from 10 cm to 60 cm*

**S04522**

Ostacolo per allenamento di plastica graduabile in altezza da cm 50 a cm 100  
*Training plastic hurdle adjustable in height from 50 cm up to 100 cm*

**S04528**

Mini cono calpestabile in PVC morbido, altezza cm 15  
*Mini cone made of super soft PVC, height 15 cm*

**S04534**

Paletto slalom di plastica con puntale in acciaio  
*Slalom pole made of plastic with metal peak*

**S04524**

Set di 24 delimitatori in plastica colorata con supporto  
*Set of 24 small cones made of coloured plastic with support*

**S04526****S04526**

Set di 48 delimitatori in plastica colorata con supporto  
*Set of 48 small cones made of coloured plastic with support*

**S04530**

Set di 48 delimitatori in plastica colorata con supporto, foro superiore sagomato per sostegno aste  
*Set of 48 small cones made of coloured plastic with support, upper hole shaped for supporting poles*

**S04532**

Griglia in plastica e tessuto per esercizi di coordinazione  
*Plastic and fabric training grill for coordination exercises*

**S04536**

Paletto slalom con base per uso indoor o per campi in sintetico  
*Slalom pole with base for indoor use or use on artificial grass court*

**S04540**

Forca per allenamento gioco testa, palloni esclusi  
*Header practice stand, balls not included*

**S04542**

Forca per allenamento gioco testa con base zavorrabile mobile su ruote, pallone escluso

*Portable header practice stand, base to be filled equipped with wheels, ball not included*

**S04544**

Sagoma gonfiabile per allenamento, altezza cm 200, con base autoportante, soffice e sicura

*Inflatable dummy for training, height 200 cm, self-standing base, soft and safe*

**S04548****S04548**

Sagoma snodata in gomma soffice per allenamento, con puntali per fissaggio a terra, altezza regolabile

*Flexible penalty dummy made of soft rubber, with ground steel peaks, height adjustable*

**S04550****S04550**

Carrello mobile di acciaio verniciato per supporto di nr 5 sagome S04548 (sagome escluse)

*Varnished steel trolley supporting 5 dummies S04548 (dummies not included)*

**S04552****S04552**

Carrello singolo per supporto e spostamento sagoma S04548 su sintetico (sagoma esclusa)

*Single trolley supporting and sliding dummy S04548 on artificial grass (dummy not included)*

**S04552 - ZOOM**



S04554

**S04554**

Paracadute con cintura per esercizi di potenziamento della corsa

*Parachute with belt useful to improve run's power*



S04556

**S04556**

Slitta con cintura in pelle, corda e moschettoni per esercizi di potenziamento della corsa e dell'accelerazione (pesi esclusi)

*Sledge with leather belt, rope and hooks useful to improve run's power and player's acceleration performance (weights not included)*



S04557

**S04557**

Telaio con rete funzionale ad allenamento portieri e giocatori, in acciaio zincato ad inclinazione regolabile, dimensioni cm 140x140

*Inclined frame with net for training goal-keepers and players, galvanized steel, dimensions 140x140 cm*

**S04558**

Macchina spara-palloni Globus Eurogoal 1500 funzionale ad un allenamento completo per il calcio, in grado di effettuare tiri in porta per allenamento dei portieri, cross ed assist per allenamento degli attaccanti; regolazione della velocità di uscita della palla fino a 140 km/h; regolazione della traiettoria del tiro e degli effetti imprimibili al pallone; funzionamento a batteria ricaricabile

*Globus Eurogoal 1500 balls shooting machine for soccer functional to a complete training session permitting to serve goal shots to goal keeper, crosses and assist with extreme realism to striker; ball's speed adjustment up to 140 km/h; possibility to adjust ball's trajectories as well as ball's spin; working with rechargeable battery*



Video dimostrativo disponibile al sito [www.sportssystem.it](http://www.sportssystem.it) nella sezione filmati.

Demonstrative video available at [www.sportssystem.it](http://www.sportssystem.it) in movies section.



S04560

**S04560**

Casacca fluorescente colorata per allenamento

*Fluorescent training coloured bib*

**S04562**

Lavagna magnetica per calcio con pedine, dimensioni cm 85x60

*Magnetic tactic charts for soccer, dimensions 85x60 cm*

13

**Carrelli segna campo, bandierine calcio angolo, accessori campi calcio**  
**Pitch marker trolleys, corner flags, accessories for soccer field**



**S04570**  
 Carrello segna campo a polvere in acciaio zincato  
*Galvanized steel pitch marker trolley using powder*



**S04571**  
 Carrello segna campo a vernice ecologica con funzionamento a rulli  
*Pitch marker trolley using ecological paint operating by rollers*



**S04572**  
 Carrello segna campo a vernice ecologica con pompa manuale  
*Pitch marker trolley using ecological paint with manual pressure pump*



**S04574**  
 Carrello segnacampo a vernice ecologica con pompa elettrica a batteria  
*Pitch marker trolley using ecological paint with electric pump operating with battery*



**S04575**  
 Carrello segnacampo a vernice ecologica con pompa a caricamento automatico di pressione  
*Pitch marker trolley using ecological paint with automatic pressure pump*



**S04576**  
 Carrello segna campo a vernice ecologica con motore a scoppio  
*Pitch marker trolley using ecological paint operating by custom engine*

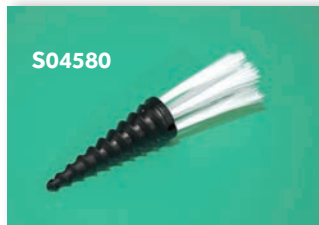

S04580

**S04578**

Vernice ecologica per carrello segna campo in fusto da 14 lt  
*Barrel with 14 lt of ecological paint*

**S04580**

Plifix accessorio per la tracciatura del campo  
*Plifix suitable for line marking*



S04584



S04582

**S04582**

Griglia per pulizia scarpe in acciaio zincato, autoportante  
*Galvanized steel self-standing grill for shoes cleaning*

**S04584**

Totem lava scarpe con struttura in acciaio verniciato completa di poggia-mani, sistema di pulizia suola e tomaia con 2+2 spazzole a setole di nylon e sistema di spruzzo in acciaio zincato con 4 getti; comprese bandelle per fissaggio a terra e raccordo per tubatura

*Shoes washing totem with handled varnished steel structure, cleaning system for shoes' upper and lower sides composed of 2+2 nylon brushes and 4 water spray nozzles; including ground fixing frame and connection to water pipe*

S04586

**S04586**

Bandierina calcio d'angolo con palo fisso antinfortunistico di plastica bianca, diametro mm 30, drappo in poliestere di colore giallo cm 60x40, bussola con tappo e clip  
*White plastic fixed corner pole, diameter 30 mm, yellow polyester flag 60x40 cm, socket with cap and clip*

S04588

**S04588**

Bandierina calcio d'angolo con palo snodato antinfortunistico di plastica bianca, diametro mm 30, drappo in poliestere di colore giallo cm 60x40, bussola con tappo e clip  
*White plastic flexible corner pole, diameter 30 mm, yellow polyester flag 60x40 cm, socket with cap and clip*



S04590

**S04590**

Drappo di ricambio in poliestere per bandierine calcio angolo, dimensioni cm 45x45, disponibile nei colori giallo, arancio e scacchi giallo/arancio  
*Spare polyester flag for corner pole 45x45 cm, available in yellow, orange and checkered yellow/orange colors*

**S04592**

Tunnel estensibile di protezione dell'accesso dei giocatori sul campo di gioco (indoor o outdoor), struttura in alluminio con movimento a pantografo su ruote, telo di PVC colorato  
*Extendable tunnel protecting players' entry on sport court (indoor or outdoor), aluminum structure scissor-style working, mobile on wheels, colored PVC cover*

**NOTE**

**Tunnel estensibile S04592 personalizzabile nelle dimensioni, dal punto di vista funzionale ed estetico, a richiesta.**

***Extendable tunnel S04592 can be customized on dimensions, under the functional and aesthetic points of view, on demand.***

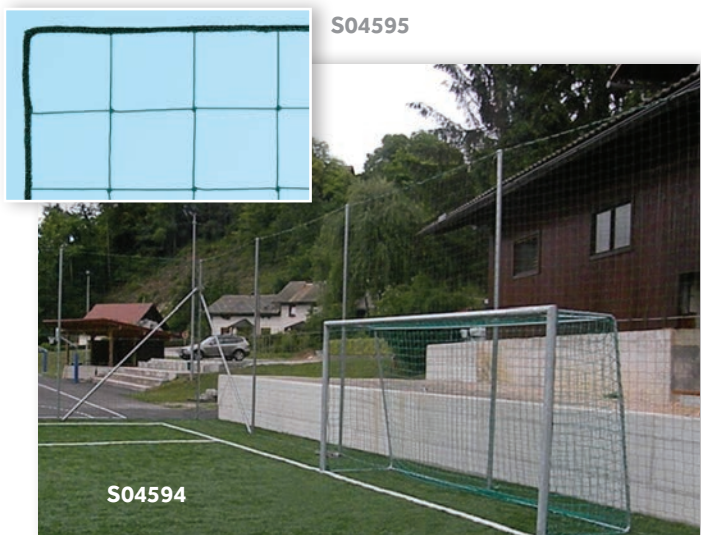
**S04594**

Rete di protezione fondocampo in polietilene verde, diametro mm 3, maglia cm 13x13, lavorazione con nodo  
*Protective boundary net made of green polyethylene, diameter 3 mm, mesh 13x13 cm, knotted*

**S04595**

Bordatura perimetrale per rete di protezione fondocampo S04594  
*Bording cord for protective boundary net S04594*

**S04596**

Veicolo ambulanza per campi calcio con supporto per barella e seduta per assistente medico, motore elettrico con funzionamento a batteria, fornito completo di carica batterie e barella pieghevole in alluminio  
*Ambulance vehicle for transferring injured players on soccer field, with stretcher support and seat for doctor, electric engine working with rechargeable battery, supplied with battery charger and foldable stretcher in aluminium*

## Calcetto - Futsal



S04602

**S04602**

Coppia porte calcetto in alluminio verniciato sezione mm 80, dimensioni cm 300x200, modello mobile con base  
*Pair of aluminium futsal goals round section 80 mm, dimensions 300x200 cm, portable model with ground base*

**S04603**

Coppia porte calcetto in alluminio verniciato sezione mm 80, dimensioni cm 300x200, modello a bussole  
*Pair of aluminium futsal goals round section 80 mm, dimensions 300x200 cm, ground sockets model*

**S04604**

Coppia porte calcetto in alluminio verniciato sezione mm 80, dimensioni cm 300x200, modello mobile con base e reggirete reclinabile  
*Pair of aluminium futsal goals round section 80 mm, dimensions 300x200 cm, portable model with ground base and hinged net supports*



S04603 - ZOOM

**S04605****NEW**

S04605



S04605

Coppia porte calcetto in alluminio verniciato sezione mm 80, dimensioni cm 300x200, modello con zavorre incluse  
*Pair of varnished aluminium futsal goals round section 80 mm, dimensions 300x200 cm, model with weights included*

**S04606**

Coppia porte calcetto in acciaio verniciato sezione mm 80, dimensioni cm 300x200, modello mobile con base e pali saldati alla traversa  
*Pair of varnished steel futsal goals round section 80 mm, dimensions 300x200 cm, portable model with ground base and posts welded to crossbar*



S04606 - S04608

**S04607**

Coppia porte calcetto in acciaio zincato sezione mm 80, dimensioni cm 300x200, modello mobile con base e pali saldati alla traversa  
*Pair of galvanized steel futsal goals round section 80 mm, dimensions 300x200 cm, portable model with ground base and posts welded to crossbar*



S04607

**S04608**

✓ EN749 tested

Coppia porte calcetto in acciaio verniciato sezione mm 80, dimensioni cm 300x200, modello smontabile, mobile con base

*Pair of varnished steel futsal goals round section 80 mm, dimensions 300x200 cm, portable mode with ground base, completely dismantled*

**S04609**

Set 4 bussole con innesti adattabili a tutti i modelli di porte in acciaio per calcetto (S04606, S04607, S04608) e per calcio ridotto (S04314, S04320, S04326)

*Set 4 sockets with connections to be installed on all steel goals for futsal (S04606, S04607, S04608) and for reduced soccer (S04314, S04320, S04326)*

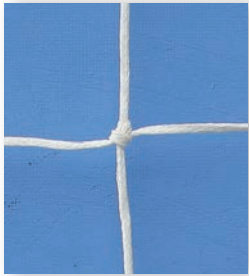
**S04610**

Coppia reti calcetto cm 300x200 in polietilene diametro mm 2,5 con nodo, profondità cm 100/100, maglia quadra cm 10x10

*Pair of nets for futsal goals 300x200 cm made of polyethylene diameter 2.5 mm knotted, depth 100/100 cm, square mesh 10x10 cm*

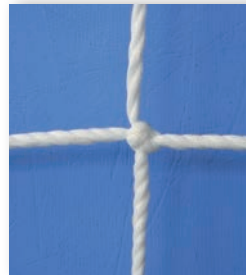
**S04612**

Coppia reti calcetto cm 300x200 in nylon diametro mm 5 con nodo, profondità cm 100/100, maglia quadra cm 10x10

*Pair of nets for futsal goals 300x200 cm made of nylon diameter 5 mm knotted, depth 100/100 cm, square mesh 10x10 cm*

**S04614****S04614**

Ventosa con clip per fissaggio a terra porte calcetto

*Suction cap with hook for goal ground fixation*

**S04615****S04615**

Sacco zavorra da kg 20 in PVC elettrosaldato con maniglia

*Ballast bag 20 kg made in electro-welded PVC with handle*

**S04616****S04616****NEW**

Modulo zavorra in acciaio zincato per porte calcetto, calcio ridotto e pallamano in acciaio

*Galvanized steel ballast module for futsal, reduced football and handball goals in steel*

15

**Pallamano - Handball****S04652****S04652**

✓ EN749 tested

Coppia porte pallamano in alluminio verniciato sezione mm 80x80, dimensioni cm 300x200, modello mobile con base

*Pair of varnished aluminium handball goals section 80x80 mm, dimensions 300x200 cm, portable model with ground base*

**S04653**

✓ EN749 tested

Coppia porte pallamano in alluminio verniciato sezione mm 80x80, dimensioni cm 300x200, modello a bussole

*Pair of varnished aluminium handball goals section 80x80 mm, dimensions 300x200 cm, ground sockets model*



S04654

**S04654**

✓ EN749 tested

Coppia porte pallamano in alluminio verniciato sezione mm 80x80, dimensioni cm 300x200, modello mobile con base e reggirete reclinabili

*Pair of varnished aluminium handball goals section 80x80 mm, dimensions 300x200 cm, portable model with ground base and hinged net supports*



S04660

**S04660**

Coppia porte pallamano in legno verniciato sezione mm 80x80, dimensioni cm 300x200, modello mobile con base

*Pair of varnished wooden handball goals section 80x80 mm, dimensions 300x200 cm, portable model with ground base*

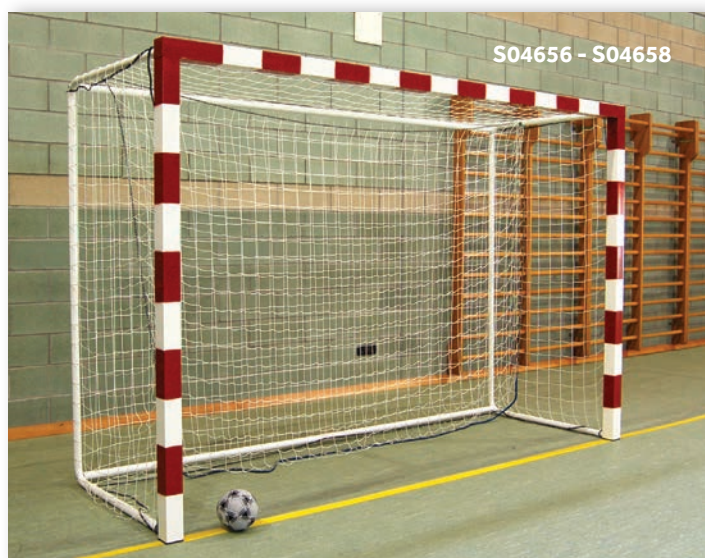

S04656 - S04658

**S04656**

✓ EN749 tested

Coppia porte pallamano in acciaio verniciato sezione mm 80x80, dimensioni cm 300x200, modello mobile con base e pali saldati alla traversa

*Pair of varnished steel handball goals section 80x80 mm, dimensions 300x200 cm, portable model with ground base and posts welded to crossbar*

**S04658**

✓ EN749 tested

Coppia porte pallamano in acciaio verniciato sezione mm 80x80, dimensioni cm 300x200, modello smontabile, mobile con base

*Pair of varnished steel handball goals section 80x80 mm, dimensions 300x200 cm, portable model with ground base, completely dismantled*

**S04662**

Coppia reti pallamano cm 300x200 in nylon diametro mm 3 senza nodo, profondità cm 100/100, maglia quadra cm 10x10

*Pair of nets for handball goals 300x200 cm made of nylon diameter 3 mm knotless, depth 100/100 cm, square mesh 10x10 cm*

**S04663**

Coppia reti pallamano cm 300x200 in nylon diametro mm 6 senza nodo, profondità cm 100/100, maglia quadra cm 10x10

*Pair of nets for handball goals 300x200 cm made of nylon diameter 6 mm knotless, depth 100/100 cm, square mesh 10x10 cm*



S04665 rete ammortizzatrice / absorbing net - ZOOM

**S04665**

Coppia appendici in nylon diametro mm 3 con corda piombata aventi funzione di ammortizzatrici per reti S04662 e S04663

*Pair of additional catch nets made of nylon 3 mm with leaded rope, to be used with nets S04662 and S04663*



S04668

**S04668**

Coppia staffe in acciaio zincato con ruota gommata per movimentazione porte pallamano

*Pair of galvanized steel supports with rubber wheel to be used for moving handball goals*



S04670

**S04670**

Coppia porte pallamano in alluminio, omologate IHF, reggirete reclinabili, dimensioni regolamentari cm 300x200, complete di accessori di fissaggio a terra

*Pair of light aluminium handball goals, IHF approved, hinged net supports, standard dimensions 300x200 cm, ground fixing accessories included*

S04672

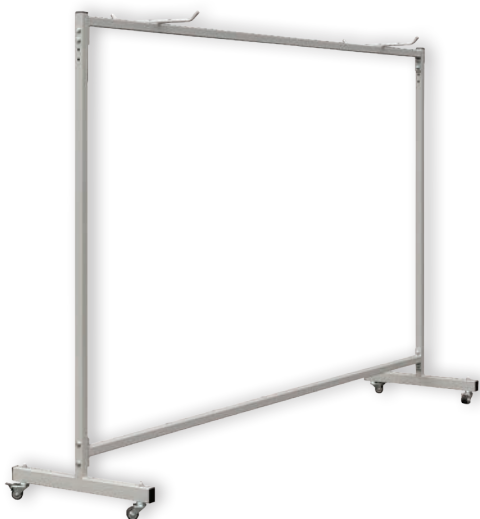
**S04672**

Carrello in acciaio verniciato per stoccaggio e movimentazione porte pallamano con reggirete reclinabili (S04654, S04670)

*Varnished steel trolley for storing and rolling away handball goals with hinged net supports (S04654, S04670)*

15

## Impianti pallavolo e protezioni Volley posts and protective pads



S04704

**S04704**

Impianto pallavolo in acciaio verniciato da fissare a parete, con dispositivo tendirete

*Wall mounted volleyball system made of varnished steel, with net tensioner*



S04706

**S04706**

Coppia protezioni imbottite per impianti pallavolo S04702 e S04704

*Pair of protective pads for volleyball systems S04702 and S04704*

**NOTE**

**Tutte le protezioni sono realizzate in gomma espansa sagomata e sono interamente rivestite in PVC (anche nell'area interna a contatto con il palo da proteggere).**

***All protective pads are made with interior in soft foam and are entirely covered in PVC (even the inside area in contact with post to be protected).***



S04708

**S04708**

Impianto pallavolo a traliccio in acciaio verniciato mobile su ruote, con dispositivo tendirete, modello scolastico

*Freestanding portable volleyball system mobile on wheels, made of varnished steel with net tensioner, school model*

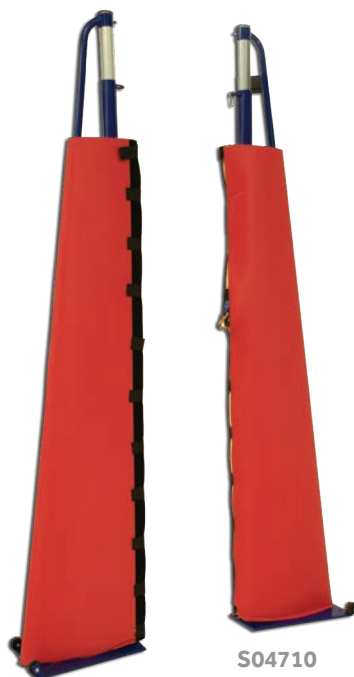

S04710

**S04710**

Coppia protezioni imbottite per impianto pallavolo S04708

*Pair of protective pads for volleyball system S04708*



S04712

**S04712**

Impianto pallavolo a traliccio in acciaio verniciato mobile su ruote, con dispositivo tendirete, modello rinforzato

*Freestanding portable volleyball system mobile on wheels, made of varnished steel with net tensioner, reinforced model*



S04714

**S04714**

Coppia protezioni imbottite per impianto pallavolo S04712

*Pair of protective pads for volleyball system S04712*



S04716

**S04716**

✓ EN1271 tested

Impianto pallavolo a traliccio in alluminio verniciato mobile su ruote, con dispositivo tendirete

*Freestanding portable volleyball system mobile on wheels, made of varnished aluminium with net tensioner*



S04717

**S04717**

Impianto pallavolo a traliccio in alluminio S04716 dotato di ruote maggiorate e cassetta porta zavorra

*Freestanding portable volleyball system S04716 equipped with larger wheels and box to be filled with ballast*



S04718

**S04718**

Serie protezioni imbottite per impianti pallavolo S04716 e S04717  
*Set of protective pads for volleyball system S04716 and S04717*



S04721

**S04721**

Impianto pallavolo monotubolare in acciaio zincato a caldo, suggerito per uso esterno, con bussole e dispositivo tendirete  
*Hot-dip galvanized steel volleyball system, suggested for outdoor use, with ground sockets and net tensioner*



S04722

**S04722**

Impianto pallavolo monotubolare in acciaio zincato con bussole e dispositivo tendirete  
*Galvanized steel volleyball system with ground sockets and net tensioner*



S04724

**S04724**

Coppia protezioni imbottite per impianti pallavolo S04721 e S04722  
*Pair of protective pads for volleyball systems S04721 and S04722*



S04726

**S04726**

Impianto pallavolo monotubolare in acciaio verniciato con bussole e dispositivo tendirete, regolazione telescopica dell'altezza, protezioni comprese, a norme FIVB  
*Varnished steel volleyball system with ground sockets and net tensioner, telescopic height adjustment, including pads, in accordance to FIVB rules*



S04728

**S04728**

Impianto pallavolo monotubolare in alluminio verniciato con bussole e dispositivo tendirete, omologato FIVB per competizioni internazionali  
*Varnished aluminium volleyball system with ground sockets and net tensioner, FIVB approved for international competitions*



S04730

**S04730**

✓ FIVB approved

Coppia protezioni imbottite per impianto pallavolo omologato FIVB  
*Pair of protective pads for volleyball system FIVB approved*

S04732

**S04732**

✓ EN1271 tested

Impianto pallavolo monotubolare in alluminio verniciato, sezione ovale, con bussole e dispositivo tendirete  
*Varnished aluminium oval section volleyball system with ground sockets and net tensioner*

S04733

**S04733**

✓ EN1271 tested

Impianto pallavolo monotubolare in alluminio verniciato, sezione ovale, con bussole e dispositivo tendirete, modello telescopico  
*Varnished aluminium oval section volleyball system with ground sockets and net tensioner, telescopic model*

S04734

**S04734**

Coppia protezioni imbottite per impianti pallavolo S04732 e S04733  
*Pair of protective pads for volleyball systems S04732 and S04733*

S04736

**S04736**

✓ EN1271 tested

Impianto pallavolo monotubolare in alluminio a sezione rotonda mm 100 secondo norma DIN 7896 con bussole, dispositivo tendirete e protezioni imbottite  
*Varnished aluminium round section 100 mm volleyball system with ground sockets, net tensioner and protective pads, in accordance to DIN 7896*

**S04738**

Dispositivo tendirete di ricambio per impianti pallavolo in acciaio S04704, S04708, S04712, S04721 e S04722  
*Net tensioner device for steel volleyball systems S04704, S04708, S04712, S04721 and S04722*

S04740

**S04740**

Dispositivo tendirete di ricambio per impianti pallavolo in alluminio S04716, S04717, S04732 e S04733  
*Net tensioner device for aluminium volleyball systems S04716, S04717, S04732 and S04733*

## Reti e accessori Nets and accessories



S04752

**S04752**

Rete pallavolo regolamentare in polietilene diametro mm 2,5 con nodo, completa di cavo in acciaio e nastro in PVC

*Standard volleyball net made of polyethylene diameter 2.5 mm knotted, complete of cable and PVC ribbon*

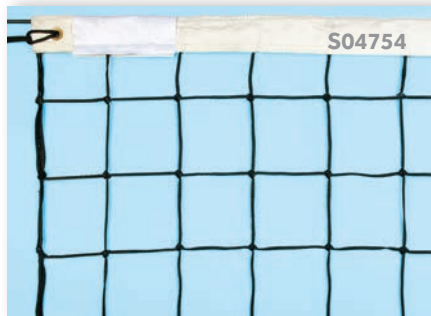

S04754

**S04754**

Rete pallavolo Torneo in polietilene diametro mm 3 con nodo, completa di nastro, cavo e bande mobili con antenne

*Torneo model net for volleyball made of polyethylene diameter 3 mm knotted, with upper ribbon, antennas' sleeves and antennas*

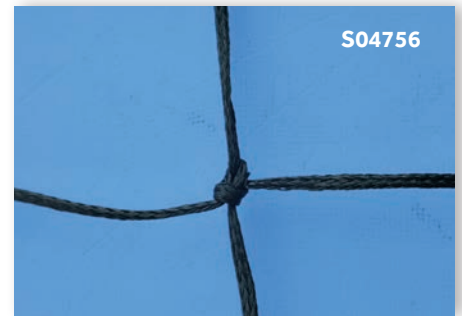

S04756

**S04756**

Rete pallavolo da competizione in polietilene diametro mm 3,5 con nodo, completa di nastri in PVC superiore da mm 70 e inferiore da mm 50, tasche porta antenne ed antenne

*Competition volleyball net made of polyethylene diameter 3.5 mm knotted, complete of PVC ribbons 70 mm on top and 50 mm on bottom, antennas' sleeves and antennas*

**S04757**

Rete pallavolo da competizione in polietilene diametro 3,5 mm con nodo, completa di nastri in PVC superiore da mm 70 e inferiore da mm 50, tasche porta antenne ed antenne. Maglia mm 45x45

*Competition volleyball net made of polyethylene diameter 3.5 mm knotted, complete of PVC ribbons 70 mm on top and 50 mm on bottom, antennas' sleeves and antennas. Mesh 45x45 mm*

**S04758**  FIVB approved

Rete pallavolo completa di antenne, omologata FIVB per competizioni

*Volleyball net with antennas, FIVB approved for competition*



S04760

**S04760**

Coppia bande mobili con tasche porta antenne

*Pair of antennas' sleeves for volleyball net*

**NOTE**

**Sport System offre la possibilità di personalizzare i nastri delle reti S04756 e S04757 con la stampa di loghi e testi.**

**Sport System offers possibility to customize, with text or logos, the two ribbons of nets S04756 and S04757.**

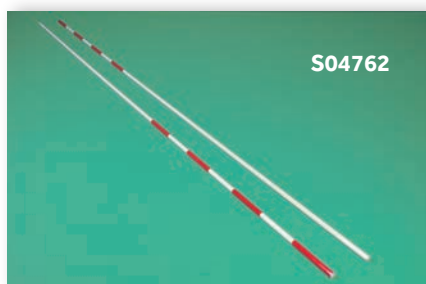
**S04762**

Coppia antenne di vetroresina in unico elemento

*Pair of single piece fibreglass antennas for volleyball net*



S04764

**S04764**

Coppia antenne di vetroresina componibili in 2 elementi

*Pair of two pieces fibreglass antennas for volleyball net*



S04765

**S04765**

Coppia antenne omologate FIVB per competizioni

*Pair of two pieces antennas FIVB approved for competition*

S04766

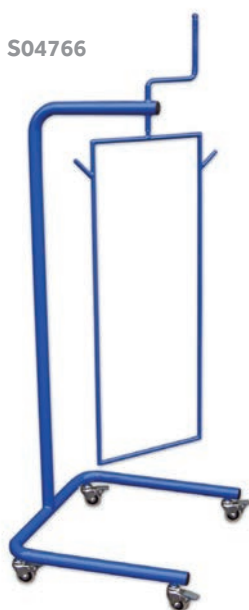
**S04766**

Avvolgitore per rete pallavolo in acciaio verniciato

*Varnished steel support for rolling up volleyball net*

**S04768****NEW**

Misuratore di plastica per verifica altezza rete pallavolo

*Plastic height measurer device for volleyball net*



S04768



S04770

**S04770**

Carrello per trasporto impianti pallavolo, reti ed accessori con struttura in acciaio verniciato, mobile su ruote

*Varnished steel trolley for volleyball posts, nets and accessories, mobile on wheels*



Inquadra il QR Code di sinistra col tuo cellulare per accedere alla sezione Giochi del sito [www.sportssystem.it](http://www.sportssystem.it)

Scan the QR Code at your right with your mobile phone to navigate the Games section at [www.sportssystem.it](http://www.sportssystem.it) site

**LINK**

Articoli per arbitro ed allenatore  
Accessories for referee and coach



S04802

**S04802**

Palchetto per arbitro pallavolo ad altezza fissa, in acciaio verniciato, mobile su ruote

*Volleyball referee platform made of varnished steel, mobile on wheels*



S04804

**S04804**

Palchetto per arbitro pallavolo ad altezza fissa con scocca di seduta, in acciaio verniciato, mobile su ruote

*Volleyball referee platform with plastic seat, made of varnished steel, mobile on wheels*



S04805

**S04805**

Protezione imbottita e sagomata per palchetti S04802 e S04804, fissaggio con Velcro

*Soft protective pad shaped for referee platforms S04802 and S04804, closure by Velcro*



S04806

**S04806**

Palchetto professionale per arbitro pallavolo regolabile in altezza con scocca di seduta, in acciaio verniciato, mobile su ruote

*Professional volleyball referee platform with adjustable height, plastic seat, made of varnished steel, mobile on wheels*

S04808

**S04808**

Protezione imbottita e sagomata per palchetto S04806, fissaggio con Velcro

*Soft protective pad shaped for referee platform S04806, closure by Velcro*

S04809

**S04809**

Protezione imbottita e sagomata per palchetto S04806, fissaggio con Velcro - modello da gara

*Soft protective pad shaped for referee platform S04806, closure by Velcro - competition model*



S04810

**S04810**

Palchetto per arbitro pallavolo, omologato FIVB per competizioni, completo di imbottiture

*Volleyball referee platform, FIVB approved for competitions, included protective pads*

S04812

**S04812**

Segnapunti manuale da tavolo per pallavolo

*Portable desk manual scoreboard for volleyball*



S04814

**S04814**

Segnapunti manuale a 4 cifre (2+2) su struttura girevole con base in acciaio verniciato

*Manual scoreboard with 4 digits (2+2) on revolving varnished steel structure with base*

**S04815**

Segnalatore acustico e luminoso portatile per time-out

*Portable time-out acoustic buzzer and light signaller*

**S04816**

Serie palette numerate in legno per sostituzione giocatori (1-18)

*Set of numbered wooden boards for player substitution (1-18)*

S04817

**S04817**

Serie palette numerate in legno per sostituzione giocatori (1-20)

*Set of numbered wooden boards for player substitution (1-20)*

**S04818**

Set cambio giocatori e time-out composto di serie palette numerate su contenitore in legno, struttura mobile in acciaio verniciato, dispositivo acustico e luminoso (1-18)

*Player substitution and time-out kit including set of numbered plastic boards on wooden case, varnished steel structure mobile on wheels, acoustic and luminous signals (1-18)*

**S04819**

Set cambio giocatori e time-out composto di serie palette numerate su contenitore in legno, struttura mobile in acciaio verniciato, dispositivo acustico e luminoso (1-20)

*Player substitution and time-out kit including set of numbered plastic boards on wooden case, varnished steel structure mobile on wheels, acoustic and luminous signals (1-20)*

S04818 - S04819

S04820

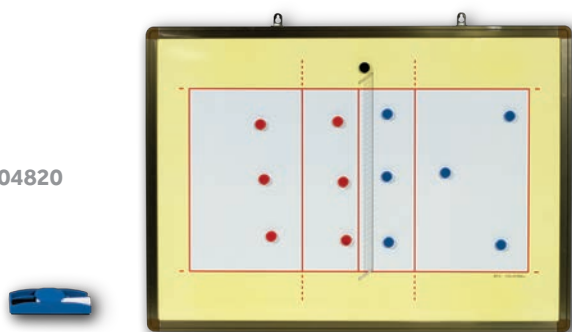
**S04820**

Lavagna magnetica per pallavolo con pedine, dimensioni cm 85x60  
*Magnetic tactic charts for volleyball, dimensions 85x60 cm*



S04822

**S04822**

Misuratore di elevazione con struttura in acciaio, mobile su ruote, base zavorrata  
*Jump performances measurer on mobile varnished steel structure, heavy base*



S04824

**S04824**

Volleyball Training per allenamento ai tiri di precisione, struttura di acciaio mobile su ruote, base zavorrata  
*Volleyball Training equipment suitable for precision training, mobile on wheels, heavy base*



S04826

**S04826**

Volleyball Player per allenamento al servizio, alla schiacciata ed al muro difensivo, struttura di acciaio mobile su ruote, base zavorrata  
*Volleyball Player equipment suitable for training on service, smash and defensive wall, heavy base*

**S04830**

Macchina spara-palloni Globus Winshot 1500 funzionale ad un allenamento completo per il volley, in grado di simulare servizi, alzate e schiacciate; regolazione della velocità di uscita della palla fino a 140 km/h; regolazione della traiettoria del tiro e degli effetti imprimibili al pallone; funzionamento a batteria ricaricabile

*Globus Winshot 1500 balls shooting machine for volley, functional to a complete training session permitting to services and attacks; ball's speed adjustment up to 140 km/h; possibility to adjust ball's trajectories as well as ball's spin; working with rechargeable battery*

18

### Pali minivolley e reti Minivolley posts and nets

S04842

**S04842**

Coppia pali minivolley in acciaio verniciato con basi zavorrabili, mobili su ruote, facilmente smontabili

*Pair of freestanding minivolley posts made of varnished steel, bases to be filled, mobile on wheels, demountable*

**S04844**

Rete super minivolley in polietilene diametro mm 3, dimensioni cm 650x100, maglia quadra cm 10x10

*Super minivolley net made of polyethylene diameter 3 mm, dimensions 650x100 cm, square mesh 10x10 cm*

**S04846**

Rete minivolley in polietilene diametro mm 3, dimensioni cm 550x100, maglia quadra cm 10x10

*Minivolley net made of polyethylene diameter 3 mm, dimensions 550x100 cm, square mesh 10x10 cm*



19

## Tennis e Padel - pali e reti

### Tennis and Padel - posts and nets



S04852

**S04852**

Coppia pali tennis per palestra in acciaio verniciato a sezione quadrata con dispositivo tendirete

*Pair of tennis posts for gym made of square section varnished steel with net tensioner*



S04854

**S04854**

✓ EN1510 tested

Coppia pali tennis per palestra in alluminio verniciato a sezione ovale con dispositivo tendirete

*Pair of tennis posts for gym made of oval section varnished aluminium with net tensioner*

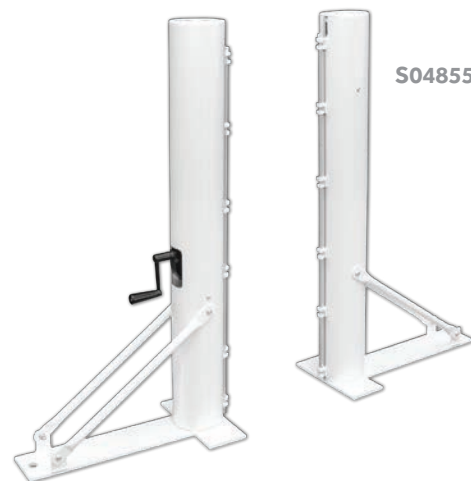

S04855

**S04855****NEW**

Coppia pali padel in alluminio a sezione ovale con piastra di fissaggio a terra e dispositivo tendirete

*Pair of padel posts made of oval section varnished aluminium with ground plate and net tensioner*



S04856

**S04856**

✓ EN1510 tested

Coppia pali tennis monotubolari in acciaio verniciato a sezione quadrata con dispositivo tendirete e bussole

*Pair of tennis posts made of square section varnished steel with ground sockets and net tensioner*



S04858

**S04858**

✓ EN1510 tested

Coppia pali tennis monotubolari in acciaio zincato a sezione quadrata con dispositivo tendirete e bussole

*Pair of tennis posts made of square section galvanized steel with ground sockets and net tensioner*



S04860

**S04860**

✓ EN1510 tested

Coppia pali tennis monotubolari in alluminio verniciato a sezione ovale con dispositivo tendirete e bussole

*Pair of tennis posts made of oval section varnished aluminium with ground sockets and net tensioner*

S04861

**S04861**

Coppia pali padel monotubolari in alluminio verniciato a sezione ovale con dispositivo tendirete e bussole  
*Pair of padel posts made of oval section varnished aluminium with ground sockets and net tensioner*

S04866

**S04866**

Dispositivo tendirete di ricambio per pali tennis e padel in alluminio S04854, S04855, S04860 e S04861  
*Net tensioner device for aluminium tennis and padel posts S04854, S04855, S04860 and S04861*



S04862

**S04862**

Impianto tennis in acciaio zincato ad elementi componibili, trasportabile su ruote, completo di pedane porta zavorra (zavorra esclusa)  
*Freestanding tennis system made of several elements in galvanized steel, mobile on wheels, complete of ballast's supports (ballast not included)*

**S04868**

Coppia paletti in acciaio zincato per sostegno rete gioco tennis singolo  
*Pair of galvanized steel net posts for single match*



S04868

**S04870**

Rete tennis regolamentare in polietilene diametro mm 2,5 con nodo, nastro in pvc, maglia quadra cm 4,5x4,5  
*Standard tennis net made of polyethylene diameter 2.5 mm knotted, complete of pvc ribbon, square mesh 4.5x4.5 cm*

**S04864**

Dispositivo tendirete di ricambio per pali tennis in acciaio S04852, S04856 e S04858  
*Net tensioner device for steel tennis posts S04852, S04856 and S04858*

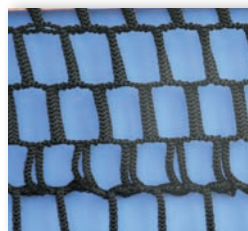
**S04872**

Rete tennis professionale in polipropilene diametro mm 4 senza nodo, 6 maglie doppie di rinforzo superiore, nastro in cotone, maglia esagonale  
*Professional tennis net made of polypropylene diameter 4 mm knotless, 6 double reinforcing mesh on upper part, complete of cotton ribbon, hexagonal mesh*

**S04873**

Rete padel professionale in polipropilene diametro mm 4 senza nodo, 6 maglie doppie di rinforzo superiore, nastro in cotone, maglia esagonale

*Professional padel net made of polypropylene diameter 4 mm knotless, 6 double reinforcing mesh on upper part, complete of cotton ribbon, hexagonal mesh*

**S04874**

Nastro in poliester per fascia superiore rete tennis

*Polyester replacing net band*



S04876

**S04876**

Centro rete tennis in poliester con gancio e fibbia

*Polyester center strap for tennis net*

20

**Sedia per arbitro, panchine e articoli vari campo tennis**  
**Referee platforms, benches and other equipment for tennis court**



S04902

**S04902**

Sedia in acciaio verniciato per arbitro tennis, completa di scocca di seduta e leggio ribaltabile, mobile su ruote

*Tennis referee platform made of varnished steel, mobile on wheels, with plastic seat and tip-up writing board*



S04904

**S04904**

Sedia in acciaio zincato per arbitro tennis, completa di scocca di seduta e leggio ribaltabile, mobile su ruote

*Tennis referee platform made of galvanized steel, mobile on wheels, with plastic seat and tip-up writing board*

S04905

**S04905**

Sedia in alluminio per arbitro tennis, completa di scocca di seduta chiudibile e leggio ribaltabile

*Tennis referee platform made of aluminium, complete of plastic tip-up chair and tip-up writing board*



S04906

**S04906**

Panchina bordo campo tennis, struttura in acciaio zincato lunghezza cm 200, seduta e schienale a doghe di legno trattato per esterno

*Bench for tennis court, galvanized steel structure length 200 cm, backrest and seating area made of wooden panels refined for outdoor use*



S04910

**S04910**

Panchina bordo campo tennis, struttura in acciaio zincato lunghezza cm 200 con nr 4 scocche di seduta in polipropilene colorato

*Bench for tennis court, galvanized steel structure length 200 cm, equipped with 4 polypropylene coloured seats*

**S04912**

Panchina bordo campo tennis, struttura in acciaio zincato lunghezza cm 100 con nr 2 scocche di seduta in polipropilene colorato

*Bench for tennis court, galvanized steel structure length 100 cm, equipped with 2 polypropylene coloured seats*

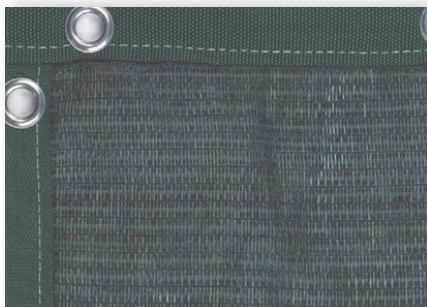
**S04914**

Telo fondo campo per campi tennis, colore verde, dimensioni mt 18x2

*Green colour boundary sheet for tennis court, dimensions 18x2 mt*

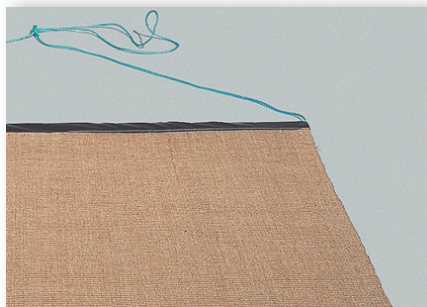
**S04916**

Stuoia livellatrice per campo tennis in cocco con asta di ferro

*Levelling coconut mat for tennis court with steel bar*

**S04918**

Fettuccia segna campo tennis in rotoli da mt 150

*Tennis court line marking tape in rolls of 150 mt*

**S04920**

Rete di protezione per campo tennis in polietilene verde, diametro mm 3, maglia cm 4,5x4,5 senza nodo  
*Protective net for tennis court made of green polyethylene, diameter 3 mm, mesh 4.5x4.5 cm without knots*

**S04921**

Bordatura perimetrale per rete di protezione per campo tennis  
*Bording cord for protective net for tennis court S04920*



S04924

S04926

**S04924**

Racchetta tennis in grafite Babolat  
*Graphite composition Babolat racket*

**S04926**

Confezione di 3 palline tennis  
*Box with 3 tennis balls*



S04930

**S04930**

Macchina spara-palline Lobster Elite 1 per allenamento al tennis  
*Lobster Elite 1 balls shooting machine for tennis training sessions*



S04932

**S04932**

Tabellone elettronico segnapunti portatile, da tavolo, per il tennis, incluso pannello di controllo integrato sul retro. Completo di batteria e carica-batteria  
*Portable desktop electronic scoreboard for tennis, including control panel integrated on back side. Supplied with battery and battery's charger*

**S04934**

NEW

Tabellone elettronico segnapunti tennis per esterno, 452RTX, dimensioni cm 150x70. Completo di console  
*Outdoor electronic scoreboard for tennis, 452RTX, dimensions cm 150x70. Including control panel*

**S04936**

NEW

Tabellone elettronico segnapunti tennis per esterno, 452RTX ALPHA con visualizzazione nomi giocatori, dimensioni cm 240x70. Completo di console  
*Outdoor electronic scoreboard for tennis, 452RTX ALPHA visualizing players' names, dimensions cm 240x70. Including control panel*

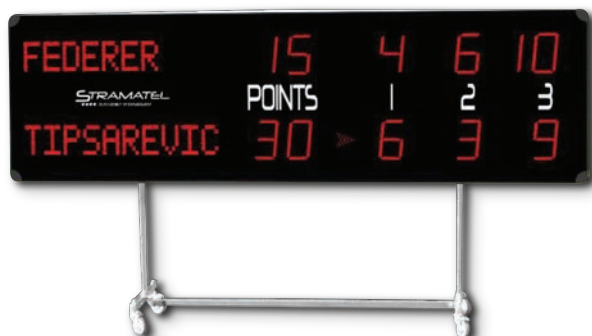

S04937

**S04937**

NEW

Carrello per sostegno e trasporto tabelloni elettronici segnapunti tennis per esterno  
*Wheeled stand for storing and moving outdoor electronic scoreboard for tennis*

21

## Badminton

S04940



## S04940

Coppia pali badminton in acciaio verniciato con basi zavorrabili, mobili su ruote, facilmente smontabili  
*Pair of freestanding badminton posts made of varnished steel, bases to be filled, mobile on wheels, demountable*



S04941



## S04941

Coppia pali badminton professionali in acciaio verniciato con basi zavorrabili, mobili su ruote, facilmente smontabili, regolabili in altezza e completi di tendirete  
*Pair of freestanding professional badminton posts made of varnished steel, bases to be filled, mobile on wheels, demountable, height adjustable and complete of net tensioner device*

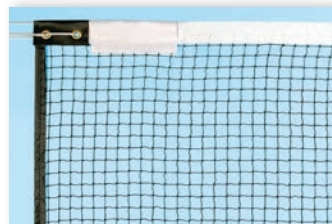

## S04942

Rete per badminton in nylon, lunghezza cm 610  
*Net for badminton made of nylon, length 610 cm*



## S04944

Racchetta per badminton regolamentare in lega di carbonio ed alluminio  
*Badminton racket made of carbon and aluminium*



## S04946

Volano per badminton in nylon, in confezione da 12 pezzi  
*Nylon shuttlecock for badminton, in box of 12 pieces*

22

Articoli per beach handball e beach soccer  
*Beach handball and beach soccer equipment*

S05002

## S05002

NEW

Coppia porte beach handball in alluminio verniciato colore blu, diametro mm 80, dimensioni cm 300x200  
*Pair of blue colour aluminium beach handball goals, round section 80 mm, dimensions 300x200 cm*

## S05004

Coppia reti beach handball in nylon  
*Pair of nets for beach handball made of nylon*

## S05006

Serie nastri demarcazione campo beach handball con picchetti  
*Set of beach handball courtlines with pickets*

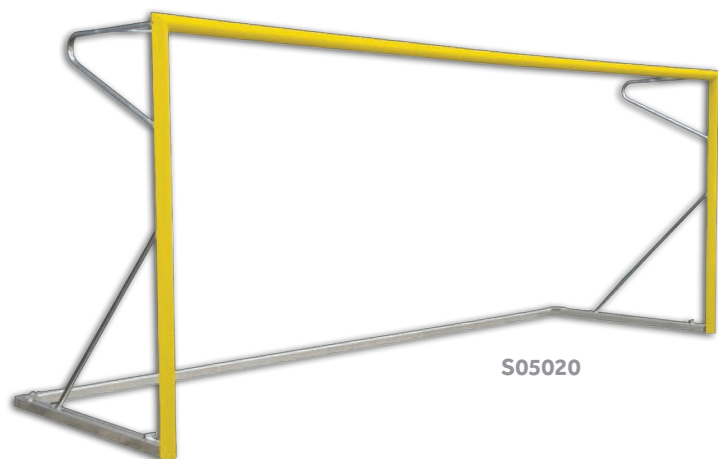

S05020

S05020



Coppia porte beach soccer in alluminio verniciato colore giallo, diametro mm 80, dimensioni cm 550x220  
*Pair of yellow colour aluminium beach soccer goals, round section 80 mm, dimensions 550x220 cm*

S05022

Coppia reti beach soccer in nylon  
*Pair of nets for beach soccer made of nylon*

S05024

Serie nastri demarcazione campo beach soccer con picchetti  
*Set of beach soccer courtlines with pickets*

23

### Articoli per beach volley e beach tennis *Beach volley and beach tennis equipment*



S05052

S05054

Impianto beach volley e beach tennis monotubolare in acciaio zincato a freddo, con bussole maggiorate e dispositivo tendirete  
*Cold galvanized steel monotubular beach volley and beach tennis system with longer ground sockets and net tensioner*



S05054



S05052

Set beach volley per uso ricreativo costituito di pali componibili con tiranti e rete, trasportabile su sacca  
*Recreational beach volley set transportable on bag including stackable posts and net*

S05056

Impianto beach volley e beach tennis monotubolare in acciaio zincato a caldo, con bussole maggiorate e dispositivo tendirete  
*Hot-dip galvanized steel monotubular beach volley and beach tennis system with longer ground sockets and net tensioner*



S05060

S05060

Coppia protezioni imbottite per impianto beach volley e beach tennis S05054 e S05056  
*Pair of protective pads for beach volley and beach tennis system S05054 and S05056*



**S05062**

Serie nastri demarcazione campo beach volley e beach tennis (mt 16x8) con picchetti

*Set of beach volley and beach tennis courtlines (16x8 mt) with pickets*

**S05063**

Rete beach volley in nylon con banda perimetrale in polipropilene

*Net for beach volley made of nylon with polypropylene edges*

**S05064**

Rete beach volley professionale in nylon con banda perimetrale in PVC, antenne comprese

*Professional net for beach volley made of nylon with PVC edges, including antennas*

**S05066**

Rete beach tennis in nylon con banda perimetrale in PVC

*Net for beach tennis made of nylon with PVC border*



S05068

**S05068**

Palchetto per arbitro beach volley con struttura di acciaio zincato

*Beach volley referee platform made of galvanized steel*



S05070

**S05070**

Palchetto per arbitro beach volley in acciaio zincato, agganciabile al palo, dotato di protezione frontale

*Beach volley referee platform made of galvanized steel, with front protective pad, to be fixed to post*





NEW

NOTE



Linea completa di attrezzi e accessori beach volley, omologati FIVB, per competizioni internazionali.

*Complete range of beach volley equipment and accessories, FIVB approved, for international competitions.*

**S05080** ✓ FIVB approved

Impianto beach volley monotubolare in alluminio verniciato con bussole e dispositivo tendirete, omologato FIVB per competizioni internazionali

*Varnished aluminium beach volley system with ground sleeves and net tensioner, FIVB approved for international competitions*



S05080



**S05082** ✓ FIVB approved

Coppia protezioni imbottite per impianto beach volley omologato FIVB  
*Pair of protective pads for beach volley system FIVB approved*

S05082

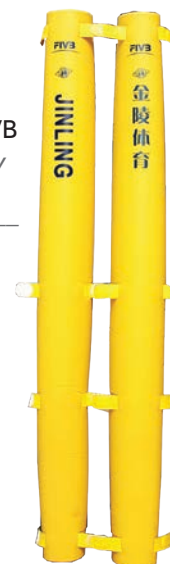

S05086

**S05084** ✓ FIVB approved

Rete beach volley completa di antenne, omologata FIVB per competizioni  
*Beach volley net with antennas, FIVB approved for competition*



S05084

**S05086** ✓ FIVB approved

Palchetto per arbitro beach volley, omologato FIVB per competizioni, completo di imbottiture  
*Beach volley referee platform, FIVB approved for competitions, included protective pads*



S05088



**S05088** ✓ FIVB approved

Serie nastri demarcazione campo beach volley con accessori, omologati FIVB  
*Set of beach volley courtlines with accessories, FIVB approved for competitions*





**Sport System** presenta una linea completa di strutture per lo streetball, conosciuto anche come **3ON3** ... dalla soluzione più semplice, fissa a terra, passando per la soluzione mobile su ruote scelta anche da **FIBA Europe**, fino ad arrivare al modello S05109.

**Sport System** presents a complete line of units for the ever more popular streetball, also known as **3ON3** ... from the most cost effective in-ground model to the portable unit selected by **FIBA Europe**, until the last developed model S05109.



S05102

#### S05102 EN1270 tested

Struttura streetball monotubolare di acciaio zincato, sbalzo cm 225, tabellone di resina melamminica su telaio con tirante di rinforzo, canestro fisso e retina

*Monotubular streetball backstop, galvanized steel structure projection 225 cm, hpl backboard on steel frame with reinforcing tie bar, fixed ring and net*

S05104



#### S05104

Struttura streetball richiudibile e trasportabile in acciaio verniciato, base porta zavorra, tabellone in resina, canestro fisso e retina, protezione frontale

*Foldable and portable streetball unit entirely in varnished steel, platform supporting ballast, hpl backboard, fixed ring with net, front protection pad*

**S05106** ✓ EN1270 tested

Struttura streetball Easyplay College in acciaio zincato mobile su ruote, sbalzo cm 125, sistema meccanico a manovella di regolazione dell'altezza, tabellone di resina melamminica su telaio, canestro fisso e retina

*Easyplay College galvanized steel portable streetball backstop mobile on wheels, projection 125 cm, mechanical height adjustment, hpl backboard on steel frame, ring and net*



S05106

**NOTE**

**La struttura streetball Easyplay College è disponibile anche con tabellone in plexiglas trasparente completo di protezione (S04206), canestro reclinabile (S04234) con retina e protezioni laterali della base, a richiesta.**

***Easyplay College streetball backstop can be equipped as well with transparent acrylic backboard with pad (S04206), reclining ring (S04234) with net and soft cushions on sides of the base, on demand.***

**S05108**

Struttura Hydroplay Club personalizzata 3ON3, interamente in acciaio zincato con carter posteriore anti-vandalismo; indicatore contasecondi integrato nella protezione frontale con copertura in policarbonato, completo di pulsantiera di comando; incluso set fodere anti-pioggia e pedana di supporto per zavorra aggiuntiva

*Hydroplay Club portable unit customized 3ON3, entirely made in galvanized steel with rear anti-vandalism shell; shot clock integrated in the main front pad, including control panel and polycarbonate cover; set of rain covers and platform supporting extra ballast included*

**3ON3** by  
**SPORTSYSTEM**

**S05109**

Struttura Hydroplay Ace personalizzata 3ON3 interamente in acciaio zincato con braccio ricurvo avente sbalzo totale cm 225; carter posteriore di protezione del sistema idraulico di movimentazione; indicatore contasecondi integrato nella protezione frontale con copertura in policarbonato, completo di pulsantiera di comando; pedana di supporto per zavorra aggiuntiva

*Hydroplay Ace portable unit customized 3ON3 entirely realized in galvanized steel with curved main arm having total projection 225 cm; rear shell protecting the oleodynamic movement unit; shot clock integrated in the main front pad under a polycarbonate shell, complete of control panel; platform supporting extra ballast*

**NOTE**

**Per realizzare un campo completo 3ON3 Sport System propone anche pavimentazione, tabellone elettronico e tribuna.**

***Complete your 3ON3 courts with modular floor, electronic scoreboard and compact stand by Sport System.***

**S05110**

Pavimentazione modulare per basket outdoor 3ON3, in piastrelle di polipropilene colorato stabilizzato ai raggi UV, facilmente posabile e rimovibile, utilizzabile anche per altri sport

*Portable modular floor for outdoor basket 3ON3, made of 25x25 cm polypropylene tiles UV resistant, easy to install and remove, useful for other different sports as well*



**S05391****NEW**

Tabellone elettronico multisport portatile da tavolo per uso esterno, MULTITOP X12, dimensioni cm 73x37, incluso pannello di controllo integrato sul retro e pulsantiera per gestione 12/24 secondi

*Tabletop portable electronic multisport scoreboard for outdoor use, MULTITOP X12, dimensions 73x37 cm, including control panel integrated on backside and shot clock controller*

**S07682**

Modulo tribuna per esterno in acciaio zincato e verniciato con scala di accesso e 2 file di sedute a scocche di polipropilene per un totale di 7 posti, con personalizzazione 3ON3

*Compact stand for outdoor use entirely made in galvanized and painted steel with stairways and walkways, 2 steps with total 7 places equipped with polypropylene seats, customized 3ON3*

**REFERENZE****ITALY****AUSTRIA****CYPRUS****REFERENCES****BULGARIA****SLOVENIA**

REFERENZE

REFERENCES



BELARUS



GEORGIA



SWITZERLAND



RUSSIA



SPAIN



ITALY

## Hockey, Unihockey



S05122

**S05122**

Coppia porte regolamentari in legno e acciaio verniciato per hockey su prato  
*Pair of standard goals for field hockey made of wood and varnished steel*

**S05124**

Coppia reti in nylon per porte hockey su prato  
*Pair of nylon nets for field hockey goals*

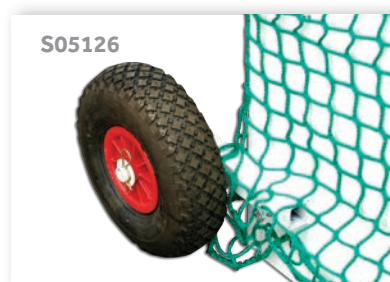

S05126

**S05126**

Coppia ruote gommata per trasporto porte hockey su prato  
*Pair of rubber wheels for field hockey goals*



S05128

**S05128**

Coppia porte regolamentari in acciaio verniciato per hockey su pista  
*Pair of standard goals for roller hockey made of varnished steel*

**S05130**

Coppia reti in nylon per porte hockey su pista  
*Pair of nylon nets for roller hockey*



S05132

**S05132**

Coppia porte unihockey in acciaio con reti, dimensioni cm 150x110  
*Pair of unihockey goals made of steel with net, dimensions 150x110 cm*

**S05134**

Set unihockey composto di 6 + 6 bastoni e 3 palline  
*Unihockey set made of 6 + 6 sticks and 3 balls*

**S05135**

Pallina in plastica bianca per unihockey  
*White plastic ball for unihockey*

26

## Rugby

**S05142**

Coppia porte rugby regolamentari in alluminio, con bussole, altezza fuori terra mt 11

*Pair of aluminium rugby goals with ground sockets, height 11 mt over ground level*

**S05144**

Set completo protezioni imbottite per porte rugby

*Complete set of protective pads for pair of rugby goals*



27

## Baseball

S05152

**S05152**

Mazza da baseball regolamentare in legno  
*Standard wooden baseball bat*

S05154

**S05154**

Mazza da baseball regolamentare in alluminio  
*Standard aluminium baseball bat*

**S05156**

Palla baseball rivestita in pelle sintetica  
*Baseball ball covered by synthetic leather*

**S05158**

Guantone baseball in pelle sintetica  
*Synthetic leather baseball glove*

**S05160****NEW**

Tabellone elettronico segnapunti baseball per esterno, 452 FBB, dimensioni cm 190x115. Completo di console

*Outdoor electronic scoreboard for baseball, 452 FBB, dimensions 190x115 cm. Including control panel*

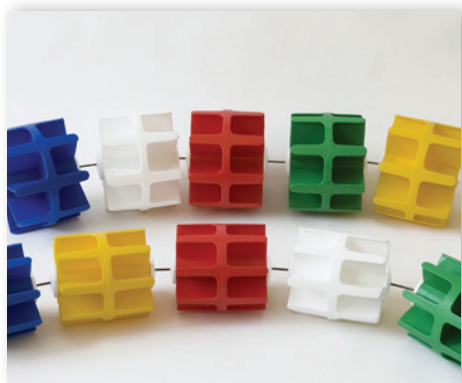

Nuoto e pallanuoto - *Swimming and water polo***S05172**

Corsia frangionda galleggiante con elementi in polipropilene colorato, diametro mm 110, completa di cavo, tenditore e molla, lunghezza mt 25  
*Swimming pool floating lane with colored polypropylene elements, diameter 110 mm, complete of cable, spring and hooks, length 25 mt*

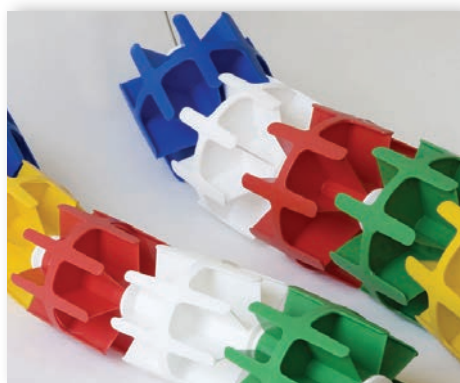
**S05174**

Corsia frangionda galleggiante con elementi in polipropilene colorato, diametro mm 110, completa di cavo, tenditore e molla, lunghezza mt 50  
*Swimming pool floating lane with colored polypropylene elements, diameter 110 mm, complete of cable, spring and hooks, length 50 mt*

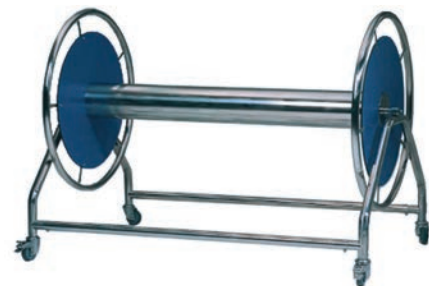
**S05176**

Carrello avvolgi corsie con struttura in acciaio inox, mobile su ruote girevoli  
*Floating lanes storage trolley made of stainless steel, mobile on wheels*

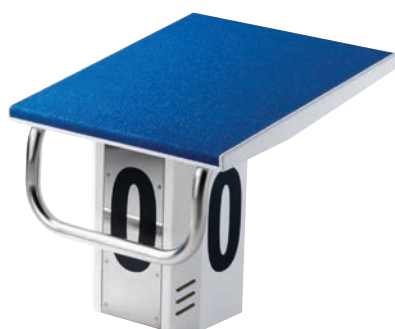
**S05178**

Blocco di partenza per piscina, in acciaio inox, piatto con superficie antiscivolo e maniglia  
*Swimming pool starting block made of stainless steel, anti-slip board's surface, with handle*

**S05180**

Pull buoy monoblocco in EVA per esercizi di apprendimento  
*Pull buoy made of EVA, for training exercises*

**S05182**

Tavoletta nuoto monoblocco in EVA per esercizi di apprendimento  
*Swimming board made of EVA, for training exercises*

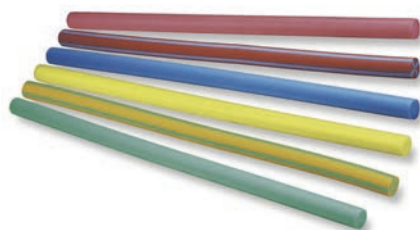
**S05184**

Cilindro galleggiante in polietilene espanso, diametro cm 7 lunghezza cm 160  
*Floating stick made of polyethylene, diameter 7 cm length 160 cm*

**S05186**

Connettore a due fori per cilindro galleggiante, in polietilene espanso  
*Two holes connecting tube for floating stick, made of polyethylene*

**S05188**

Occhialino nuoto monoblocco, finitura antifog  
*Swimming pool goggle antifog*

**S05190**

Cuffia nuoto in gomma colorata, misura senior  
Coloured rubber swimming pool cap, size senior

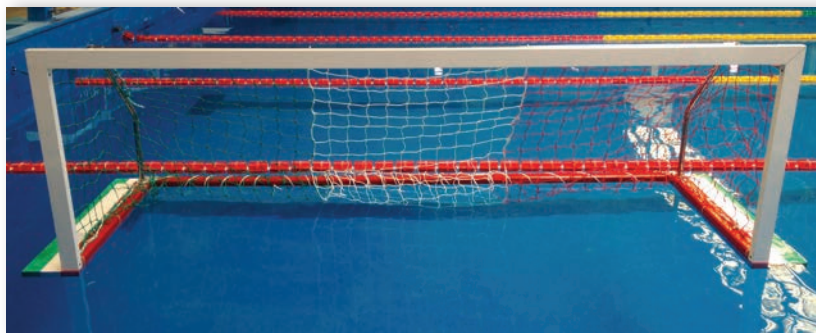
**S05192**

Coppia porte pallanuoto regolamentari in alluminio con base galleggiante

Pair of standard aluminium goals for waterpolo with floating base

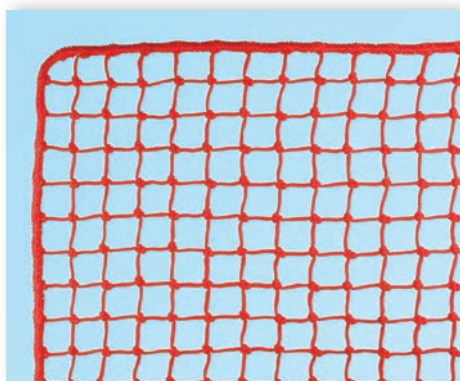
**S05194**

Coppia reti in polietilene diametro mm 5 per porte pallanuoto

Pair of polyethylene nets diameter 5 mm for waterpolo goals

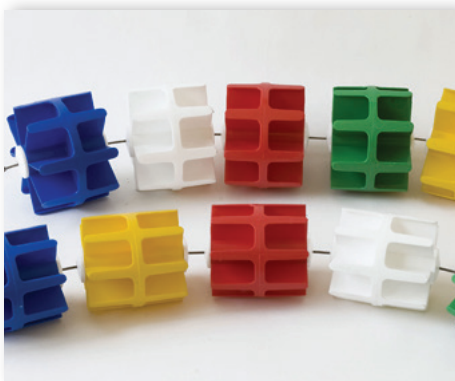
**S05196**

Set corsie galleggianti per demarcazione campo pallanuoto regolamentare su piscina da mt 50

Set of floating lanes for marking waterpolo playfield on 50 mt long swimming pool

**S05198**

Set 13 cuffie pallanuoto numerate

Set of 13 waterpolo caps numbered

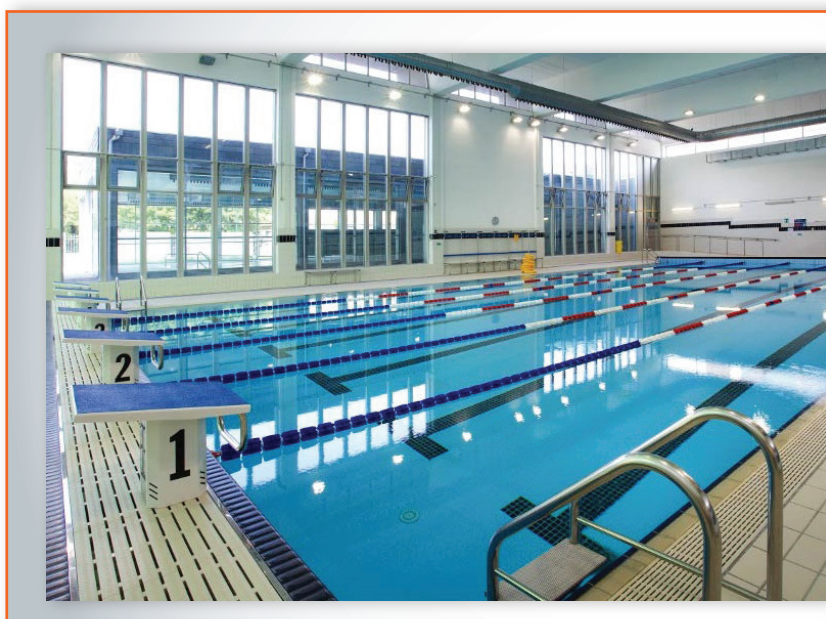
**NOTE**

A richiesta Sport System può fornire una linea completa di attrezzature ed arredi per il piano vasca, **100% Made in Italy.**

On demand Sport System can supply a complete range of equipment and furniture for the swimming pool basin, **100% Made in Italy.**

S05202

**S05202**

Set multifunzione ricreativo per gioco volley, minivolley e tennis composto di 2 strutture con base zavorrabile, mobili su ruote.

Rete esclusa

*Multipurpose recreational set for volley, minivolley and tennis made of 2 freestanding portable structures with base to be filled, mobile on wheels. Net not included*

S05206

**S05206**

Impianto multifunzione professionale volley, minivolley, tennis e salto in alto composto di 2 strutture mobili su ruote con base zavorrata in acciaio zincato, palo di alluminio e cursore scorrevole. Rete esclusa

*Multipurpose professional set for volley, minivolley, tennis and high jump made of 2 stands with heavy galvanized steel base mobile on wheels, aluminium post, adjustable support for net or crossbar. Net not included*

S05208

**S05208**

Coppia tabelloni di plastica con canestro su supporto in acciaio verniciato per impianto multifunzione S05206

*Pair of plastic backboards with ring, mounted on steel frame, for multipurpose stands S05206*

**S05209**

Set completo di protezioni imbottite per impianto multifunzione professionale S05206

*Complete set of protective pads for multipurpose professional set S05206*



S05209

S05210

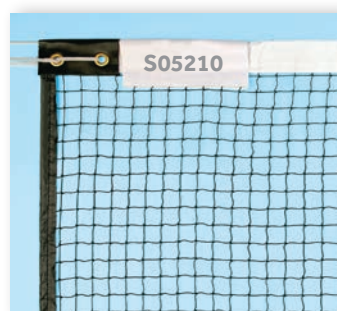
**S05210**

Rete per impianto multifunzione professionale, dimensioni mt 9x1

*Net for professional multipurpose stands, dimension 9x1 mt*



S05212

**S05212**

Coppia strutture netball mobili su ruote con canestri ad altezza regolabile, basi zavorrate in acciaio, pali in due elementi di acciaio zincato a sezione quadrata, protezioni con altezza cm 200 in gomma espansa rivestita

*Pair of netball units mobile on wheels with ring adjustable in height, heavy bases made of steel, square section galvanized steel posts made of two elements, protective pads with height 200 cm*



S05214

**S05214**

Coppia strutture netball professionali con canestri ad altezza fissa, sostegni in acciaio verniciato diametro mm 60, bussole da cementare, protezioni in gomma espansa rivestita con altezza cm 300 e diametro esterno cm 20

*Pair of professional netball units with rings at fixed height, varnished steel posts round section 60 mm, ground sockets, protective pads with height 300 cm and outside diameter 20 cm*



31

## Articoli tennis tavolo - Table tennis equipment



S05222

**S05222**

Tavolo tennis per interno pieghevole e mobile su ruote, completo di sostegni e retina

*Indoor tennis table foldable and movable on wheels, including net set*



S05226

**S05226**

Tavolo tennis per esterno pieghevole e mobile su ruote, telaio di supporto rinforzato, completo di sostegni e retina

*Outdoor tennis table foldable and movable on wheels, reinforced frame profile, including net set*



S05228

**S05228**

Tavolo tennis per interno pieghevole e mobile su ruote, telaio di supporto rinforzato, completo di sostegni e retina, omologato ITTF

*Indoor tennis table foldable and movable on wheels, reinforced frame profile, including net set, ITTF approved*

**S05230**

Coppia di sostegni metallici con retina in nylon per tavolo tennis

*Pair of metal net supports with nylon net for table tennis*

**S05232**

Retina in nylon per tavolo tennis

*Nylon net for table tennis*

**S05234**

Racchetta per tennis tavolo con gomma liscia su ambo i lati

*Table tennis bat with smooth rubber on both sides*

**S05236**

Confezione di 6 palline per tennis tavolo bianche o gialle

*Box with 6 table tennis balls white or yellow*



S05238

**S05238**

Segnapunti manuale da tavolo

*Portable desk scoreboard for table tennis*

**S05240**

Robot spara-palline Joola Shorty funzionale ad un allenamento completo al tennis tavolo

*Robot Joola Shorty functional for a complete training on table tennis*



S05240



S05252

**S05252**

Calciobalilla senza gettoniera, gambe in acciaio verniciato, scocca di multistrato, aste cromate

*Football table without coins slot, varnished steel legs, chipboard body, chromed rods*



S05254

**S05254**

Calciobalilla con gettoniera, gambe in acciaio, scocca di multistrato, aste cromate

*Football table with coins slot, varnished steel legs, chipboard body, chromed rods*



S05262

**S05262**

Carambola senza gettoniera, struttura di legno, piano di gioco in ardesia cm 180x90, incluso set accessori

*Pool table without coins slot, wooden structure, slate playing surface 180x90 cm, including set of accessories*

**S05264**

Carambola con gettoniera, struttura rinforzata, piano di gioco in ardesia cm 200x100, incluso set accessori

*Pool table with coins slot, reinforced structure, slate playing surface 200x100 cm, including set of accessories*



S05264

NEW

**Sport System** presenta una **LINEA** completa di tabelloni elettronici multisport, dalla soluzione più semplice alle alternative omologate **FIBA**.

**Sport System** presents a complete **LINE** of multisport electronic scoreboards, from the simplest one up to the most professional alternatives **FIBA** approved.

**S05300**

Console di comando 700, multisport con display touchscreen per gestione tabelloni elettronici FC e FS. Completa di trasmettitore radio

*Touchscreen multisport control panel 700, with radio transmitter integrated, suitable to control electronic scoreboards FC and FS*



S05300



S05301

**S05301**

Pulsantiera "time-console-03" collegabile alla console multisport per gestione degli indicatori 24'

*"Time-console-03" keyboard to be connected to control panel 700, suitable to control 24' shot clocks*



S05302

**S05302**

Valigetta in plastica per contenimento console di comando multisport ed eventuali pulsantiere "time-console-03"

*Plastic case for control panel 700 and "time-console-03" keyboards*

**S05303**

Tabellone elettronico multisport portatile da tavolo PS-M, dimensioni cm 55x35, incluso pannello di controllo integrato sul retro

*Tabletop portable electronic multisport scoreboard PS-M, dimensions 55x35 cm, including control panel integrated on back side*

## NOTE

**Attenzione:** tabelloni forniti privi di console di comando, da ordinare separatamente.

**Attention:** electronic scoreboards supplied without control panel to be ordered separately.

**S05306**

Tabellone elettronico multisport FC50H15, dimensioni cm 90x60, trasmissione radio, altezza cifre cm 15  
 Multisport electronic scoreboard FC50H15, dimensions 90x60 cm, radio transmission, digits height 15 cm

**S05307**

Tabellone elettronico multisport FC50H20, dimensioni cm 140x75, trasmissione radio, altezza cifre cm 20  
 Multisport electronic scoreboard FC50H20, dimensions 140x75 cm, radio transmission, digits height 20 cm

**S05308**

Tabellone elettronico multisport FC50H25, dimensioni cm 140x85, trasmissione radio, altezza cifre cm 25  
 Multisport electronic scoreboard FC50H25, dimensions 140x85 cm, radio transmission, digits height 25 cm

**S05309**

Tabellone elettronico multisport FC50H25N con nomi squadre programmabili, dimensioni cm 140x110, trasmissione radio, altezza cifre cm 25  
 Multisport electronic scoreboard FC50H25N with programmable teams' name, dimensions 140x110 cm, radio transmission, digits height 25 cm

**S05310**

Tabellone elettronico multisport FC54H25N12A1 con nomi squadre programmabili e falli dei singoli giocatori, dimensioni cm 240x145, trasmissione radio, altezza cifre cm 25  
 Multisport electronic scoreboard FC54H25N12A1 with programmable teams' name and personal fouls, dimensions 240x145 cm, radio transmission, digits height 25 cm





S05311



Tabellone elettronico multisport FC62H25N12B2 con nomi squadre programmabili, numero e falli dei singoli giocatori, penalità, dimensioni cm 260x200, trasmissione radio, altezza cifre cm 25

*Multisport electronic scoreboard FC62H25N12B2 with programmable teams' name, number and personal fouls, penalties, dimensions 260x200 cm, radio transmission, digits height 25 cm*



S05316

Tabellone elettronico multisport FS110, dimensioni cm 200x120, trasmissione via cavo

*Multisport electronic scoreboard FS110, dimensions 200x120 cm, cable transmission*

S05318

Tabellone elettronico come S05316, trasmissione via radio

*Multisport electronic scoreboard as S05316, radio transmission*



S05320

Tabellone elettronico multisport FS110N con nomi squadre programmabili, dimensioni cm 200x120, trasmissione via cavo

*Multisport electronic scoreboard FS110N with programmable teams' name, dimensions 200x120 cm, cable transmission*

S05322

Tabellone elettronico come S05320, trasmissione via radio

*Multisport electronic scoreboard as S05320, radio transmission*

**Attenzione:** gli articoli S05316, S05318, S05320, S05322 non visualizzano i falli di squadra per il basket.

**Attention:** articles S05316, S05318, S05320, S05322 do not show team's fouls for basket.

NOTE

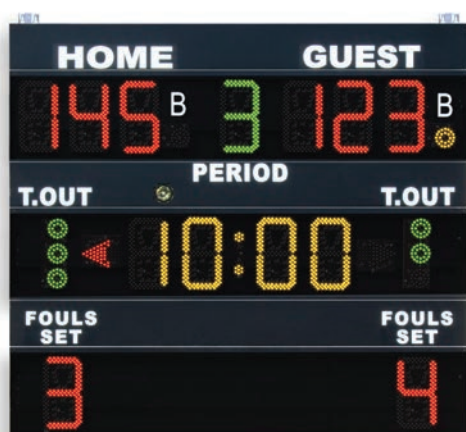

S05324

Tabellone elettronico multisport FS120 con visualizzazione falli/set, dimensioni cm 200x180, trasmissione via cavo

*Multisport electronic scoreboard FS120 visualizing fouls/set, dimensions 200x180 cm, cable transmission*

S05326

Tabellone elettronico come S05324, trasmissione via radio

*Multisport electronic scoreboard as S05324, radio transmission*

**S05328** ✓ FIBA - Level 2

Tabellone elettronico multisport FS120N con nomi squadre programmabili e visualizzazione falli/set, dimensioni cm 200x180, trasmissione via cavo

*Multisport electronic scoreboard FS120N with programmable teams' name and visualization of fouls/set, dimensions 200x180 cm, cable transmission*

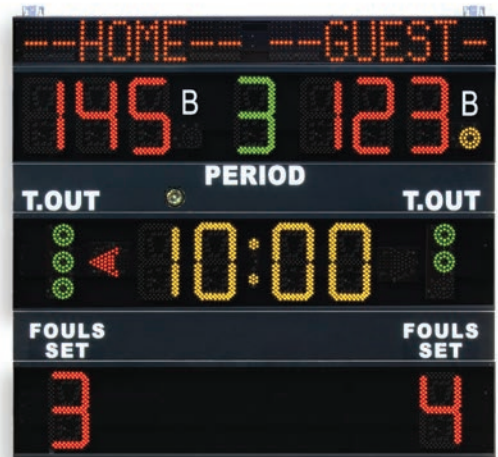
**S05330** ✓ FIBA - Level 2

Tabellone elettronico come S05328, trasmissione via radio

*Multisport electronic scoreboard as S05328, radio transmission*

**S05332**

Tabellone elettronico multisport FS130 con visualizzazione dettagli ultimo fallo (nr giocatore e nr fallo personale), dimensioni cm 200x180, trasmissione via cavo

*Multisport electronic scoreboard FS130 visualizing details of last foul (nr of player and nr of personal foul), dimensions 200x180 cm, cable transmission*

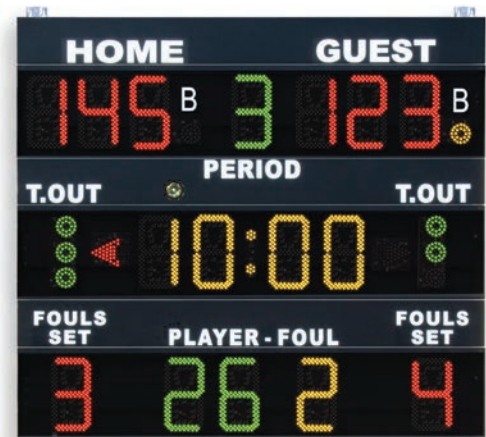
**S05334**

Tabellone elettronico come S05332, trasmissione via radio

*Multisport electronic scoreboard as S05332, radio transmission*

**S05336** ✓ FIBA - Level 2

Tabellone elettronico multisport FS130N con nomi squadre programmabili e visualizzazione dettagli ultimo fallo (nr giocatore e nr fallo personale), dimensioni cm 200x180, trasmissione via cavo

*Multisport electronic scoreboard FS130N with programmable teams' name and visualization of details of last foul (nr of player and nr of personal foul), dimensions 200x180 cm, cable transmission*

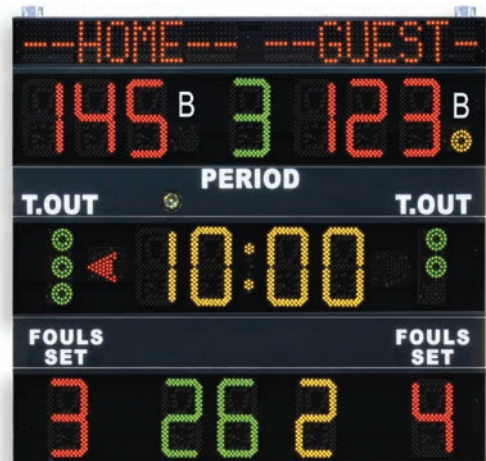
**S05338** ✓ FIBA - Level 2

Tabellone elettronico come S05336, trasmissione via radio

*Multisport electronic scoreboard as S05336, radio transmission*

**S05340**

Tabellone elettronico FS140 per la visualizzazione di due tempi di penalità per squadra, dimensioni cm 200x100, integrabile ad un qualsiasi tabellone elettronico della linea FS

*Electronic scoreboard FS140 displaying two penalty times per team, dimensions 200x100 cm, to be connected to FS line main scoreboard*



**S05342**

Tabellone elettronico FS150 per la visualizzazione di tre tempi di penalità per squadra, dimensioni cm 200x140, integrabile ad un qualsiasi tabellone elettronico della linea FS  
*Electronic scoreboard FS150 displaying three penalty times per team, dimensions 200x140 cm, to be connected to FS line main scoreboard*

**S05346**

Tabellone elettronico FS160 per la visualizzazione dei punteggi dei set per la pallavolo, dimensioni cm 200x60, integrabile ad un qualsiasi tabellone della linea FS  
*Electronic scoreboard FS160 visualizing sets' results for volley, dimensions 200x60 cm, to be connected to FS line main scoreboard*

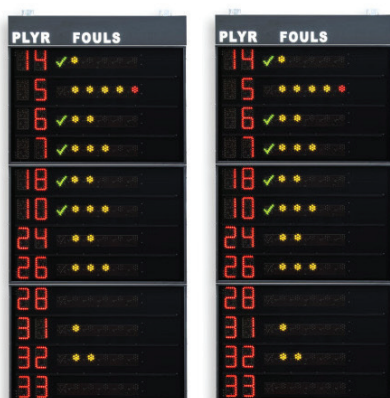
**S05350**

Coppia guanciaie laterali FS-412B con visualizzazione nr di maglia di 12 giocatori (programmabili) e falli personali a punti luminosi, dimensione di ciascun guanciaie cm 120x260  
*Pair statistics panels FS-412B visualizing 12 players' number (programmable) and personal fouls by luminous points, dimensions of each panel 120x260 cm*

**S05352**

Coppia guanciaie laterali FS-414B con visualizzazione nr di maglia di 14 giocatori (programmabili) e falli personali a punti luminosi, dimensione di ciascun guanciaie cm 120x320  
*Pair statistics panels FS-414B visualizing 14 players' number (programmable) and personal fouls by luminous points, dimensions of each panel 120x320 cm*

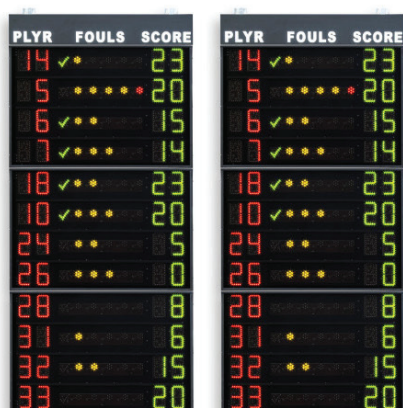
**S05354**

Coppia guanciaie laterali FS-412C con visualizzazione nr di maglia di 12 giocatori (programmabili), falli personali a punti luminosi e punteggio, dimensione di ciascun guanciaie cm 120x260  
*Pair statistics panels FS-412C visualizing 12 players' number (programmable), personal fouls by luminous points and personal score, dimensions of each panel 120x260 cm*

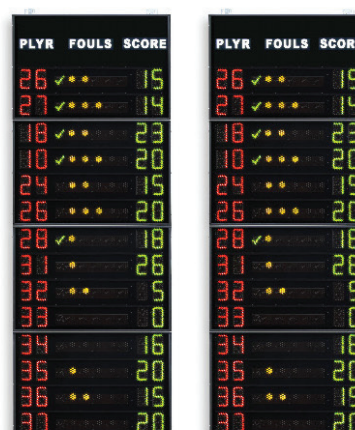
**S05356**

Coppia guanciaie laterali FS-414C con visualizzazione nr di maglia di 14 giocatori (programmabili), falli personali a punti luminosi e punteggio, dimensione di ciascun guanciaie cm 120x320  
*Pair statistics panels FS-414C visualizing 14 players' number (programmable), personal fouls by luminous points and personal score, dimensions of each panel 120x320 cm*

**S05366**

Coppia guanciaie laterali FS-412F con visualizzazione nome programmabile di 12 giocatori a 12 caratteri, dimensioni di ciascun guanciaie cm 145x240  
*Pair side panels FS-412F visualizing 12 players' name, programmable with 12 characters, dimensions of each panel 145x240 cm*

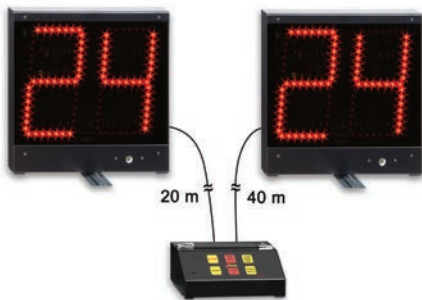
**S05370**

Kit 24/14" composto di nr 2 indicatori dimensioni cm 30x30 con cifre altezza cm 20 ed una pulsantiera di comando, trasmissione via cavo, valori programmabili  
*KIT 24/14" composed of 2 shot clocks dimensions 30x30 cm with 20 cm high digits and control panel, cable transmission, programmable values*

**S05372** ✓ FIBA - Level 2

Coppia indicatori 24/14" WSC-24s con batteria ricaricabile, da appoggiare a terra, dimensioni cm 30x32, collegabili alla console del tabellone elettronico principale, trasmissione radio

*Pair of 24/14" shot clocks WSC-24s self-standing with rechargeable battery, dimensions 30x32 cm, to be connected to main scoreboard's control panel, radio transmission*

**S05374** ✓ FIBA - Level 2

Coppia indicatori 24/14" FS-24S-H20 dimensioni cm 40x30 con cifre altezza cm 20, collegabili alla console del tabellone elettronico principale o funzionante con console S05375, trasmissione via cavo

*Pair of 24/14" shot clocks FS-24S-H20 dimensions 40x30 cm with 20 cm high digits, to be connected to main scoreboard's control panel or to control panel S05375, cable transmission*

**S05375**

Console di comando per utilizzo dell'articolo S05374 anche in assenza di tabellone elettronico principale

*Control panel for using article S05374 even without any main scoreboard*

**S05376** ✓ FIBA - Level 2

Coppia indicatori 24/14" come S05374, trasmissione radio

*Pair of 24/14" shot clocks as S05374, radio transmission*



**S05378** ✓ FIBA - Level 2

Coppia indicatori 24/14" monofacciali FS-24S-1B con visualizzazione tempo di gioco, dimensioni cm 70x60, collegabili alla console del tabellone elettronico principale, trasmissione via cavo

*Pair of 24/14" single-face shot clocks FS-24S-1B visualizing game's time, dimensions 70x60 cm, to be connected to main scoreboard's control panel, cable transmission*

**S05380** ✓ FIBA - Level 2

Coppia indicatori 24/14" come S05378, trasmissione radio

*Pair of 24/14" shot clocks as S05378, radio transmission*

**S05382** ✓ FIBA - Level 2

Coppia indicatori 24/14" trifacciali FS-24S-3B con visualizzazione tempo di gioco, dimensioni cm 70x60, collegabili alla console del tabellone elettronico principale, trasmissione via cavo

*Pair of 24/14" three-faces shot clocks FS-24S-3B visualizing game's time, dimensions 70x60 cm, to be connected to main scoreboard's control panel, cable transmission*

**S05384** ✓ FIBA - Level 2

Coppia indicatori 24/14" come S05382, trasmissione radio

*Pair of 24/14" shot clocks as S05382, radio transmission*

**S05386** ✓ FIBA - Level 2

Coppia indicatori 24/14" quadrifacciali FS-24S-4B con visualizzazione tempo di gioco, dimensioni cm 70x60, collegabili alla console del tabellone elettronico principale, trasmissione via cavo

*Pair of 24/14" four-faces shot clocks FS-24S-4B visualizing game's time, dimensions 70x60 cm, to be connected to main scoreboard's control panel, cable transmission*

**S05388** ✓ FIBA - Level 2

Coppia indicatori 24/14" come S05386, trasmissione radio

*Pair of 24/14" shot clocks as S05386, radio transmission*

**S05390**

Display LED per ambiente sportivo indoor con funzione promozionale e comunicativa, dimensioni cm 300x200. Fornito con struttura di supporto e sistema di controllo

*LED display for indoor sports hall with promotional and communication functions, dimensions 300x200 cm. Supplied with supporting structure and control system*



## LINEA PER ESTERNO - OUTDOOR LINE

## S05391 NEW

Tabellone elettronico multisport portatile da tavolo per uso esterno, MULTITOP X12, dimensioni cm 73x37, incluso pannello di controllo integrato sul retro e pulsantiera per gestione 12/24 secondi

*Tabletop portable electronic multisport scoreboard for outdoor use, MULTITOP X12, dimensions 73x37 cm, including control panel integrated on backside and shot clock controller*



## S05393 NEW

Tabellone elettronico multisport per uso esterno, 452XME3000, dimensioni cm 120x65, trasmissione via radio, compresa console di comando

*Electronic multisport scoreboard for outdoor use, 452XME3000, dimensions 120x65 cm, radio transmission, including control panel*



## S05395 NEW

Tabellone elettronico per uso esterno, 452 FRB, per calcio, rugby e hockey, dimensioni cm 180x100, trasmissione via radio, compresa console di comando

*Electronic scoreboard for outdoor use, 452 FRB, for football, rugby and hockey, dimensions 180x100 cm, radio transmission, including control panel*



## S05397 NEW

Tabellone elettronico per uso esterno, 452 FRB AD, per calcio, rugby e hockey, visualizzazione del nome delle squadre o messaggi in movimento, dimensioni cm 200x100, trasmissione via radio, compresa console di comando

*Electronic scoreboard for outdoor use, 452 FRB AD, for football, rugby and hockey, programmable teams' names or moving message, dimensions 200x100 cm, radio transmission, including control panel*



## NOTE

**Attenzione:** I tabelloni elettronici della linea per esterno sono forniti completi di console di comando.

**Attention:** Outdoor line's electronic scoreboards are supplied complete of control panel.



**S05402**

Pallone minibasket in gomma-nylon,  
misura 5

*Rubber-nylon mini-basket ball, size 5*

**S05404**

Pallone minibasket in gomma-nylon  
Molten, misura 5

*Molten rubber-nylon mini-basket ball,  
size 5*

**S05406**

Pallone basket femminile in  
gomma-nylon, misura 6

*Rubber-nylon female basket ball, size 6*

**S05408**

Pallone basket femminile in pelle  
sintetica da allenamento Molten,  
misura 6

*Molten synthetic leather female basket  
ball for training, size 6*

**S05410**

Pallone basket femminile in pelle  
sintetica Molten omologato FIBA,  
misura 6

*Molten synthetic leather female basket  
ball FIBA approved, size 6*

**S05412**

Pallone basket in gomma-nylon,  
misura 7

*Rubber-nylon basket ball, size 7*

**S05414**

Pallone basket in gomma-nylon Molten,  
misura 7

*Molten rubber-nylon basket ball,  
size 7*

**S05416**

Pallone basket in pelle sintetica da  
allenamento, misura 7

*Synthetic leather basket ball for training,  
size 7*

**S05418**

Pallone basket in pelle sintetica da  
allenamento Molten, misura 7

*Molten synthetic leather basket ball for  
training, size 7*

**S05420**

Pallone basket in pelle sintetica Molten  
omologato FIBA, misura 7

*Molten synthetic leather basket ball FIBA  
approved, size 7*

**S05452**

Pallone calcetto in gomma-nylon,  
misura 4

*Rubber-nylon futsal ball, size 4*

**S05454**

Pallone calcetto indoor in feltro cucito,  
misura 4

*Felt futsal ball for indoor use, size 4*

**S05456**

Pallone calcetto in pelle sintetica da  
allenamento, misura 4

*Synthetic leather futsal ball, size 4*

**S05458**

Pallone calcetto in pelle sintetica a  
rimbalzo ridotto da gara, misura 4

*Synthetic leather futsal ball for  
competition, reduced rebound, size 4*

**S05460**

Pallone calcetto in pelle sintetica Select  
da gara, misura 4

*Select synthetic leather futsal ball for  
competition, size 4*

**S05462**

Pallone calcio in gommapiuma diametro  
cm 20

*Foam soccer ball diameter 20 cm*

**S05464**

Pallone calcio in gomma-nylon, misura 5

*Rubber-nylon soccer ball, size 5*

**S05466**

Pallone calcio in pelle sintetica da  
allenamento, misura 5

*Synthetic leather soccer ball for training,  
size 5*

**S05468**

Pallone calcio in pelle sintetica Select  
omologato FIFA, misura 5

*Select synthetic leather soccer ball FIFA  
approved, size 5*

**S05470**

Pallone con gancio per forca palloni in  
pelle sintetica

*Synthetic leather soccer ball with hook  
for header practice stand*

**NOTE**

Scarica il Catalogo aggiornato di Sport System dal sito  
[www.sportssystem.it](http://www.sportssystem.it)

Download the last edition of Sport System's Catalogue at  
[www.sportssystem.it](http://www.sportssystem.it)



36

## Palloni pallamano - Handball balls

**S05502**

Pallone pallamano maschile in gomma-nylon, misura 3  
*Rubber-nylon male handball, size 3*

**S05504**

Pallone pallamano maschile in pelle sintetica da allenamento, misura 3  
*Synthetic leather male handball for training, size 3*

**S05506**

Pallone pallamano maschile in pelle sintetica Select omologato IHF, misura 3  
*Select synthetic leather male handball IHF approved, size 3*

**S05508**

Pallone pallamano femminile in gomma-nylon, misura 2  
*Rubber-nylon female handball, size 2*

**S05510**

Pallone pallamano femminile in pelle sintetica da allenamento, misura 2  
*Synthetic leather female handball for training, size 2*

**S05512**

Pallone pallamano femminile in pelle sintetica Select omologato IHF, misura 2  
*Select synthetic leather female handball IHF approved, size 2*

37

## Palloni volley e minivolley - Volley and minivolley balls

**S05552**

Pallone minivolley ufficiale FIPAV  
*Official FIPAV minivolley ball*

**S05554**

Pallone super minivolley  
*Super minivolley ball*

**S05556**

Pallone pallavolo in gomma-nylon bicolore, misura 5  
*Rubber-nylon volley ball two colours, size 5*

**S05558**

Pallone pallavolo in pelle sintetica da allenamento, misura 5  
*Synthetic leather volley ball for training, size 5*

**S05560**

Pallone pallavolo in pelle sintetica da allenamento Mikasa, misura 5  
*Mikasa synthetic leather volley ball for training, size 5*

**S05562**

Pallone pallavolo in pelle sintetica da allenamento Molten, misura 5  
*Molten synthetic leather volley ball for training, size 5*

**S05564**

Pallone pallavolo in pelle sintetica  
Mikasa omologato FIVB, misura 5  
*Mikasa synthetic leather volley ball FIVB  
approved, size 5*

**S05566**

Pallone pallavolo in pelle sintetica  
Molten omologato FIVB, misura 5  
*Molten synthetic leather volley ball FIVB  
approved, size 5*

38

### Palloni per sport da spiaggia, rugby e pallanuoto

#### *Balls for beach sports, rugby and waterpolo*

**S05602**

Pallone beach handball super soft  
*Super soft beach handball ball*

**S05604**

Pallone beach soccer in pelle sintetica  
super soft  
*Super soft synthetic leather beach soccer  
ball*

**S05606**

Pallone beach volley in pelle sintetica  
super soft  
*Super soft synthetic leather beach volley  
ball*

**S05608**

Pallone rugby in pelle sintetica  
*Synthetic leather rugby ball*

**S05610**

Pallone pallanuoto maschile in  
gomma-nylon  
*Rubber-nylon waterpolo ball for male*

**S05612**

Pallone pallanuoto femminile in  
gomma-nylon  
*Rubber-nylon waterpolo ball for female*

## Cesti porta palloni, accessori di gonfiaggio

### Balls trolleys, inflating accessories

**S05652**

Gabbia porta palloni in acciaio verniciato mobile su ruote

*Varnished steel ball carrier mobile on wheels*

**S05654**

Gabbia porta palloni in acciaio zincato mobile su ruote

*Galvanized steel ball carrier mobile on wheels*

**S05656**

Carrello porta palloni pieghevole, struttura in acciaio verniciato, sacco in nylon

*Foldable ball transporter, varnished steel structure, nylon basket*

**S05658**

Carrello espositore per palloni in acciaio verniciato mobile su ruote

*Varnished steel wheelaway ball rack*

**S05660**

Pompa a staffa per gonfiaggio palloni

*Hand pump inflating balls*

**S05662**

Pompa a staffa con serbatoio per gonfiaggio palloni

*Hand pump with tank inflating balls*

**S05664**

Compressore elettrico per gonfiaggio palloni

*Electric ball compressor inflating balls*

**S05666**

Rete porta palloni in nylon

*Nylon net carrying balls*

**S05702**

Coppia parastinchi professionali con paramalleoli

*Pair of soccer players' shinguards*

**S05704**

Paio guanti portiere con palmo di gomma

*Pair of soccer goalkeeper gloves*

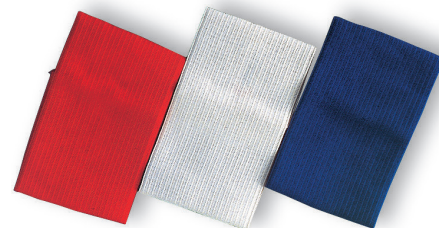
**S05706**

Fascia da capitano in tessuto elastico con Velcro

*Elastic arm belts for captain*

**S05708**

Fischietto Fox 40 ufficiale per arbitro

*Fox 40 official whistle for referee*

**S05710**

Paio ginocchiere volley con foro posteriore

*Pair of volleyball players' knee protectors*

**S05714**

Nastro taping per protezione dita giocatori pallavolo, in rotolo da mt 25

*Taping band for protecting volleyball players' fingers, 25 mt long*

**S05718**

Completo maschile calcio, pallamano o pallavolo composto di maglia a manica corta e pantaloni, eventualmente personalizzabile con numeri o serigrafie varie

*Male uniform suitable for soccer, handball and volleyball composed of t-shirt and pants, eventually customizable with numbers or logos*

**S05720**

Completo femminile pallavolo composto di canotta e pantaloni, eventualmente personalizzabile con numeri o serigrafie varie

*Female uniform suitable for volleyball composed of vest and pants, eventually customizable with numbers or logos*

Reversible  
Reversible

**S05722**

Completo maschile e femminile basket reversibile composto di canotta e pantaloni bi-colore, eventualmente personalizzabile con numeri o serigrafie varie

*Female and male double-face uniform suitable for basketball composed of vest and pants in 2 colors, eventually customizable with numbers or logos*

**NOTE**

**I completi S05718, S05720, S05722 possono essere personalizzati con numeri o serigrafia.**

**Uniforms S05718, S05720, S05722 can be customized with numbers or logos, on demand.**

**S05724**

Borsa sportiva in tessuto poliestere, con vano portascarpe  
*Sporting bag made in polyester with shoes shelter*

**S05725**

Borsa in tessuto porta medicinali, con tasche esterne  
*Polyester medicine bag with outside pockets*

**S05726**

Ghiaccio chimico istantaneo in busta  
*Instant cold compress, ice pack*

**S05728**

Ghiaccio spray in bomboletta da ml 400  
*Cooling spray in can of 400 ml*





## ARREDI

Nella categoria Arredi è presentata la linea di arredi ed accessori per il completamento funzionale dei **campi di gioco indoor e outdoor** e per **l'allestimento dei locali annessi alle aree di gioco**, disegnati e prodotti con attenzione particolare alla qualità dei materiali utilizzati e delle finiture proposte e con attenzione alla **possibilità di personalizzare le soluzioni standard** secondo le esigenze del cliente, sia dal punto di vista estetico che pratico.



## FURNITURE

*A complete range of **furnishing and accessories** enabling customers to entirely equip any sport venue (from the spectators' area to changing room, from infirmaries to meeting and press rooms ...). All products designed and manufactured with priority given to using best quality materials, level of fittings and **the option of customizing each single product**, both from an aesthetic and functional point of view and based on customer's demand.*

1

## Armadi porta attrezzi - Equipment lockers

**S07002**

Armadio porta attrezzi di lamiera verniciata ad ante battenti con vano interno porta valori, dimensioni cm 100x45x200

*Equipment locker made from varnished sheet steel with shelves and lockable compartment for valuables inside, dimensions 100x45x200 cm*

**S07004**

Armadio porta attrezzi di lamiera verniciata ad ante battenti con 4 ripiani, dimensioni cm 100x45x200

*Equipment locker made from varnished sheet steel with 4 shelves inside, dimensions 100x45x200 cm*

**S07006**

Armadio porta attrezzi di lamiera verniciata ad ante scorrevoli con 4 ripiani, dimensioni cm 120x45x200

*Equipment locker made from varnished sheet steel with 4 shelves inside and sliding doors, dimensions 120x45x200 cm*

**S07008**

Armadio porta attrezzi con pareti in rete metallica zincata e 2 ripiani, dimensioni cm 155x75x160 mobile su ruote, smontabile

*Equipment trolley mobile on wheels, made of galvanized steel mesh walls with 2 shelves, dimensions 155x75x160 cm, can be dismantled*

**S07010**

Scaffalatura in lamiera a 5 ripiani, dimensioni cm 100x40x200

*Steel shelter with 5 shelves, dimensions 100x40x200 cm*



## Arredo infermeria - Furniture for infirmary

**S07102**

Armadio con anta a battente, 4 ripiani, pareti in vetro temperato e chiusura a chiave

*Infirmery locker with 1 door, 4 shelves, tempered glass walls*

**S07104**

Armadio con 2 ante a battente, 4 ripiani, pareti in vetro temperato e chiusura a chiave

*Infirmery locker with 2 doors, 4 shelves, tempered glass walls*

**S07106**

Paravento a 3 ante con struttura pieghevole di acciaio cromato

*Three shutter screen with foldable chromed steel structure*

**S07108**

Appendiabiti a colonna di acciaio verniciato e plastica

*Varnished steel and plastic clothes stand*

**S07110**

Scrivania a 3 cassetti con chiusura a chiave, struttura di metallo verniciato e piano di nobilitato bilaminato

*Desk with 3 drawers key secured, made of varnished steel structure and chipboard surface*

**S07112**

Poltroncina imbottita con struttura metallica cromata e braccioli, ignifuga  
*Padded fireproof armchair with chromed steel structure*

**S07114**

Sedia imbottita con struttura metallica cromata, ignifuga  
*Padded fireproof chair with chromed steel structure*

S07116 + S07118 + S07120

**S07116**

Lettino visita medica con testiera reclinabile, struttura di acciaio cromato e verniciato, piani imbottiti e rivestiti  
*Medical examination couch with reclining headrest, chromed and varnished steel structure, padded and coated surfaces*

**S07117**

Lettino visita medica con testiera reclinabile, struttura di acciaio cromato e verniciato, piani imbottiti e rivestiti, completo di foro per respirazione e tappo  
*Medical examination couch with reclining headrest, chromed and varnished steel structure, padded and coated surfaces, complete with breathing hole and bung*

S07122

**S07118**

Porta rotolo in acciaio cromato per lettino visita medica  
*Paper roll holder for examination couch made of chromed steel*

**S07120**

Rotolo di carta per lettino visita medica  
*Roll of paper for examination couch*

**S07122**

Lettino visita medica e massaggi pieghevole e trasportabile, struttura in metallo, piani imbottiti e rivestiti  
*Foldable and transportable examination and massage couch, metal structure, padded and coated surfaces*

**S07123**

Letto massaggi a due segmenti imbottiti e rivestiti in similpelle, regolabili elettricamente in altezza ed inclinazione, testiera con foro per respirazione, struttura in acciaio verniciato  
*Medical examination couch made of two padded and vinyl covered sections electrically adjustable in height and inclination, headpiece with breathing hole, varnished steel structure*

---

**S07124**

Sgabello girevole di alluminio  
*Turnable stool made of aluminium*

---

**S07126**

Sgabello girevole di acciaio verniciato con sedile imbottito  
*Turnable stool with varnished steel structure and padded seat*

---

**S07128**

Scaletta scendiletto a 2 gradini con struttura in acciaio cromato  
*Chromed steel bedside step ladder with 2 steps*

---

**S07130**

Porta rifiuti in metallo con coperchio azionabile a pedale  
*Metal pedal trashcan*

---

**S07132**

Porta rifiuti di plastica colorata  
*Coloured plastic trashcan*

---

**S07134**

Portantina porta feriti pieghevole con struttura di acciaio cromato  
*Foldable stretcher with chromed steel frame*

---

**S07136**

Cassetta medica portatile applicabile a parete con kit accessori secondo d.m. 388

*Portable first aid kit box to be fixed to the wall including set of first aid accessories*

**S07138**

Cassetta medica da fissare a parete con kit accessori secondo d.m. 388

*Wall mounted first aid kit cabinet including set of first aid accessories*

**S07140**

Autorespiratore AMBU in valigetta di ABS contenente mascherina, apribocca, tiralingua

*AMBU life-support system with accessories, in plastic case*

**S07142**

Sfigmomanometro senza mercurio da tavolo con display LCD, completo di fonendoscopio

*Tabletop use sphygmomanometer mercury-free with LCD display, complete of stethoscope*

**S07146**

Carrello porta strumenti mobile su ruote, struttura con maniglie in alluminio, ripiani in bilaminato con sponde, dimensioni cm 60x40x80

*Medical trolley with aluminium structure and handles, mobile on wheels, white laminated shelves with guard-rail, dimensions 60x40x80 cm*

**S07148**

Bilancia pesa persone con statimetro

*Scales for persons with height measurer*

**S07150**

Defibrillatore semiautomatico esterno (DAE) portatile su valigetta, completo di istruzioni

*Semi-automatic external defibrillator (AED) portable on case, complete of instructions*

**NOTE**

Con il Decreto del Consiglio dei Ministri n.44 del 5/9/2012 è fatto obbligo a tutte le società sportive di dotarsi di un defibrillatore semiautomatico esterno (DAE), per maggiori informazioni scrivere a [info@sportssystem.it](mailto:info@sportssystem.it)

*In Italy it is now mandatory for each sport club to have an AED device available in proper facility.*

3

**Armadi spogliatoio in lamiera - Sheet steel wardrobes and lockers**
**S07202**

Armadio spogliatoio a 1 posto di lamiera verniciata, dimensioni cm 37x35x180

*Varnished sheet steel wardrobe at 1 door, dimensions 37x35x180 cm*

**S07206**

Armadio spogliatoio a 2 posti di lamiera verniciata, dimensioni cm 70x35x180

*Varnished sheet steel wardrobe at 2 doors, dimensions 70x35x180 cm*

**S07208**

Armadio spogliatoio a 2 posti di lamiera verniciata con ante colorate, dimensioni cm 70x35x180

*Varnished sheet steel wardrobe at 2 coloured doors, dimensions 70x35x180 cm*

**S07204**

Armadio spogliatoio a 1 posto di lamiera verniciata con anta colorata, dimensioni cm 37x35x180

*Varnished sheet steel wardrobe at 1 coloured door, dimensions 37x35x180 cm*

**S07210**

Armadio spogliatoio a 3 posti di lamiera verniciata, dimensioni cm 103x35x180

*Varnished sheet steel wardrobe at 3 doors, dimensions 103x35x180 cm*

**S07214**

Armadio spogliatoio a 4 posti (2+2) di lamiera verniciata, dimensioni cm 70x35x180

*Varnished sheet steel wardrobe at 4 doors (2+2), dimensions 70x35x180 cm*

**S07212**

Armadio spogliatoio a 3 posti di lamiera verniciata con ante colorate, dimensioni cm 103x35x180

*Varnished sheet steel wardrobe at 3 coloured doors, dimensions 103x35x180 cm*

**S07216**

Armadio spogliatoio a 4 posti (2+2) di lamiera verniciata con ante colorate, dimensioni cm 70x35x180

*Varnished sheet steel wardrobe at 4 coloured doors (2+2), dimensions 70x35x180 cm*

**S07218**

Armadio spogliatoio a 6 posti (3+3) di lamiera verniciata, dimensioni cm 103x35x180

*Varnished sheet steel wardrobe at 6 doors (3+3), dimensions 103x35x180 cm*

**S07222**

Armadio casellario a 10 posti (2x5h) di lamiera verniciata, dimensioni cm 70x35x180

*Varnished sheet steel small compartments locker with 10 doors (2x5h), dimensions 70x35x180 cm*

**S07220**

Armadio spogliatoio a 6 posti (3+3) di lamiera verniciata con ante colorate, dimensioni cm 103x35x180

*Varnished sheet steel wardrobe at 6 coloured doors (3+3), dimensions 103x35x180 cm*

**S07224**

Armadio casellario a 10 posti (2x5h) di lamiera verniciata con ante colorate, dimensioni cm 70x35x180

*Varnished sheet steel small compartments locker with 10 coloured doors (2x5h), dimensions 70x35x180 cm*

**S07226**

Armadio casellario a 15 posti (3x5h) di lamiera verniciata, dimensioni cm 103x35x180

*Varnished sheet steel small compartments locker with 15 doors (3x5h), dimensions 103x35x180 cm*

**S07228**

Armadio casellario a 15 posti (3x5h) di lamiera verniciata con ante colorate, dimensioni cm 103x35x180

*Varnished sheet steel small compartments locker with 15 coloured doors (3x5h), dimensions 103x35x180 cm*



S07226

## Armadi spogliatoio in laminato - HPL wardrobes



### S07252

Armadio spogliatoio in laminato stratificato con giunti di nylon e piedini di acciaio regolabili. Colonna con due vani aventi dimensioni cm 30x50x90

*Locker made of hpl panels with nylon joints, steel adjustable feet. Column with two compartments having dimensions 30x50x90 cm*

### S07254

Armadio spogliatoio in laminato stratificato con giunti di nylon e piedini di acciaio regolabili. Nr 2 colonne con due vani aventi dimensioni cm 30x50x90

*Locker made of hpl panels with nylon joints, steel adjustable feet. Nr 2 columns with two compartments having dimensions 30x50x90 cm*

### S07256

Armadio spogliatoio in laminato stratificato con giunti di nylon e piedini di acciaio regolabili. Nr 3 colonne con due vani aventi dimensioni cm 30x50x90

*Locker made of hpl panels with nylon joints, steel adjustable feet. Nr 3 columns with two compartments having dimensions 30x50x90 cm*

### S07258

Armadio spogliatoio in laminato stratificato con giunti di nylon e piedini di acciaio regolabili. Colonna con singolo vano avente dimensioni cm 30x50x180

*Locker made of hpl panels with nylon joints, steel adjustable feet. Column with single compartment having dimensions 30x50x180 cm*

### S07260

Armadio spogliatoio in laminato stratificato con giunti di nylon e piedini di acciaio regolabili. Nr 2 colonne con singolo vano avente dimensioni cm 30x50x180

*Locker made of hpl panels with nylon joints, steel adjustable feet. Nr 2 columns with single compartment having dimensions 30x50x180 cm*

### S07262

Armadio spogliatoio in laminato stratificato con giunti di nylon e piedini di acciaio regolabili. Nr 3 colonne con singolo vano avente dimensioni cm 30x50x180

*Locker made of hpl panels with nylon joints, steel adjustable feet. Nr 3 columns with single compartment having dimensions 30x50x180 cm*



### S07264

Armadio spogliatoio in laminato stratificato su profili in alluminio e piedini regolabili. Colonna con due vani aventi dimensioni cm 30x50x90

*Locker made of hpl panels mounted on aluminium profiles, steel adjustable feet. Column with two compartments having dimensions 30x50x90 cm*

### S07266

Armadio spogliatoio in laminato stratificato su profili in alluminio e piedini regolabili. Nr 2 colonne con due vani aventi dimensioni cm 30x50x90

*Locker made of hpl panels mounted on aluminium profiles, steel adjustable feet. Nr 2 columns with two compartments having dimensions 30x50x90 cm*

### S07268

Armadio spogliatoio in laminato stratificato su profili in alluminio e piedini regolabili. Nr 3 colonne con due vani aventi dimensioni cm 30x50x90

*Locker made of hpl panels mounted on aluminium profiles, steel adjustable feet. Nr 3 columns with two compartments having dimensions 30x50x90 cm*

### S07270

Armadio spogliatoio in laminato stratificato su profili in alluminio e piedini regolabili. Colonna con singolo vano avente dimensioni cm 30x50x180

*Locker made of hpl panels mounted on aluminium profiles, steel adjustable feet. Column with single compartment having dimensions 30x50x180 cm*

### S07272

Armadio spogliatoio in laminato stratificato su profili in alluminio e piedini regolabili. Nr 2 colonne con singolo vano avente dimensioni cm 30x50x180

*Locker made of hpl panels mounted on aluminium profiles, steel adjustable feet. Nr 2 columns with single compartment having dimensions 30x50x180 cm*

### S07274

Armadio spogliatoio in laminato stratificato su profili in alluminio e piedini regolabili. Nr 3 colonne con singolo vano avente dimensioni cm 30x50x180

*Locker made of hpl panels mounted on aluminium profiles, steel adjustable feet. Nr 3 columns with single compartment having dimensions 30x50x180 cm*

## Cabine spogliatoio vip - VIP locker room modules

**S07275**

Modulo spogliatoio individuale interamente realizzato con pannelli di nobilitato melaminico con seduta e schienale imbottiti e rivestiti in ecopelle. Personalizzabile nella composizione e nelle dimensioni di vani a giorno e vani chiusi, nella scelta dei colori e con ricamo testo o logo su schienale. Dimensioni indicative cm 70x90x210h

*Locker room individual module entirely made of coloured melamine panels with seating element and backrest padded and synthetic leather covered. To be customized on composition and size of open and closed cells, on colours selection and by embroidering text or logo on backrest. Indicative dimensions cm 70x90x210h*

**S07276**

Modulo spogliatoio individuale VIP composto di cabina principale sagomata con asta appendiabiti e mensole, colonna armadio con ripiani e porta chiudibile a chiave, il tutto realizzato in laminato stratificato colorato, compresa poltrona in pelle sintetica incassata nella cabina principale. Soluzione completamente personalizzabile nelle dimensioni, nella finitura, nella combinazione cromatica oltre che nella scelta del modello di poltrona

*VIP locker room individual module composed of main cabin with shelves and clothes hanger rail, side column with shelves and lockable door, all the above made in colored hpl, including synthetic leather covered armchair to be installed inside main cabin. Solution to be totally customized on dimensions, finishing, chromatic combinations over than the choice of armchair model*

**NOTE**

**LA GIUSTA SOLUZIONE PER QUALSIASI ESIGENZA! - THE RIGHT CHOICE FOR ANY DEMAND!**

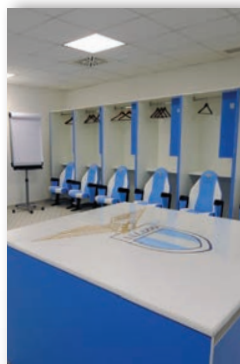



6

## Panchine spogliatoio con struttura di acciaio - Steel structure benches

S07301

**S07301**

Panchina spogliatoio semplice, struttura di acciaio verniciato e listoni di legno, lunghezza mt 1

*Locker room bench, varnished steel structure and wooden planks, length 1 mt*

**S07302**

Panchina spogliatoio semplice, struttura in acciaio verniciato e listoni di legno, lunghezza mt 1,5

*Locker room bench, varnished steel structure and wooden planks, length 1.5 mt*

S07303

**S07303**

Panchina spogliatoio semplice, struttura di acciaio verniciato e listoni di legno, lunghezza mt 2

*Locker room bench, varnished steel structure and wooden planks, length 2 mt*



S07304

**S07304**

Panchina spogliatoio con schienale, struttura di acciaio verniciato e listoni di legno, lunghezza mt 1

*Locker room bench with backrest, varnished steel structure and wooden planks, length 1 mt*

**S07305**

Panchina spogliatoio con schienale, struttura di acciaio verniciato e listoni di legno, lunghezza mt 1,5

*Locker room bench with backrest, varnished steel structure and wooden planks, length 1.5 mt*

S07306

**S07306**

Panchina spogliatoio con schienale, struttura di acciaio verniciato e listoni di legno, lunghezza mt 2

*Locker room bench with backrest, varnished steel structure and wooden planks, length 2 mt*

**S07307**

Panchina spogliatoio con schienale e doga appendiabiti, struttura di acciaio verniciato e listoni di legno, lunghezza mt 1

*Locker room bench with backrest and wooden clothes hanger rail, varnished steel structure and wooden planks, length 1 mt*

**S07308**

Panchina spogliatoio con schienale e doga appendiabiti, struttura di acciaio verniciato e listoni di legno, lunghezza mt 1,5

*Locker room bench with backrest and wooden clothes hanger rail, varnished steel structure and wooden planks, length 1.5 mt*

Panchine testate secondo la norma EN 16139.

**NOTE**

*Locked room benches tested accordingly to EN 16139 standard.*



S07309

**S07309**

Panchina spogliatoio con schienale e doga appendiabiti, struttura di acciaio verniciato e listoni di legno, lunghezza mt 2

*Locker room bench with backrest and wooden clothes hanger rail, varnished steel structure and wooden planks, length 2 mt*

**S07311**

Panchina spogliatoio completa, struttura di acciaio verniciato e listoni di legno, lunghezza mt 1,5

*Complete locker room bench, varnished steel structure and wooden planks, length 1.5 mt*



S07312

**S07312**

Panchina spogliatoio completa, struttura di acciaio verniciato e listoni di legno, lunghezza mt 2

*Complete locker room bench, varnished steel structure and wooden planks, length 2 mt*

S07310

**S07310**

Panchina spogliatoio completa, struttura di acciaio verniciato e listoni di legno, lunghezza mt 1

*Complete locker room bench, varnished steel structure and wooden planks, length 1 mt*

**S07313**

Panchina spogliatoio completa ad isola per posizionamento a centro locale, struttura di acciaio verniciato e listoni di legno, lunghezza mt 1

*Double side complete locker room bench, varnished steel structure and wooden planks, length 1 mt*

**S07314**

Panchina spogliatoio completa ad isola per posizionamento a centro locale, struttura di acciaio verniciato e listoni di legno, lunghezza mt 1,5

*Double side complete locker room bench, varnished steel structure and wooden planks, length 1.5 mt*

**S07315**

Panchina spogliatoio completa ad isola per posizionamento a centro locale, struttura di acciaio verniciato e listoni di legno, lunghezza mt 2

*Double side complete locker room bench, varnished steel structure and wooden planks, length 2 mt*



S07318

**S07318**

Panca per disabili, struttura di acciaio, piano ribaltabile di cm 100x60 e doppio piano porta oggetti

*Bench for disabled people, varnished steel structure, reclining seating area 100x60 cm with double shelves*

**S07320**

Attaccapanni con porta borse da fissare a parete, struttura di acciaio verniciato e listoni di legno, lunghezza mt 2 con 6 grucce di nylon

*Clothes hanger rail with bags support to be fixed to the wall, varnished steel structure and wooden planks, length 2 mt with 6 nylon hangers*

**S07321**

Attaccapanni con porta borse da fissare a parete, struttura di acciaio verniciato e listoni di legno, lunghezza mt 1,5 con 4 grucce

*Clothes hange rail with bags support to be fixed to the wall, varnished steel structure and wooden planks, length 1.5 mt with 4 nylon hangers*

**S07322**

Attaccapanni con porta borse da fissare a parete, struttura di acciaio verniciato e listoni di legno, lunghezza mt 1 con 3 grucce di nylon

*Clothes hanger rail with bags support to be fixed to the wall, varnished steel structure and wooden planks, length 1 mt with 3 nylon hangers*

**S07324**

Tavola attaccapanni di legno da fissare a parete, lunghezza mt 2 con 6 grucce di nylon

*Wooden clothes hanger rail to be fixed to the wall, length 2 mt with 6 nylon hangers*

**S07325**

Tavola attaccapanni di legno da fissare a parete, lunghezza mt 1,5 con 4 grucce

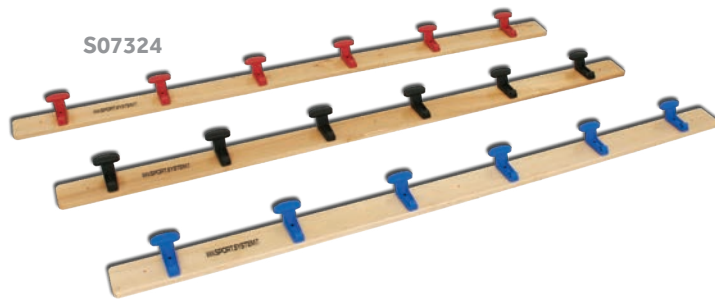
*Wooden clothes hanger rail to be fixed to the wall, length 1.5 mt with 4 nylon hangers*

**S07326**

Tavola attaccapanni di legno da fissare a parete, lunghezza mt 1 con 3 grucce di nylon

*Wooden clothes hanger rail to be fixed to the wall, length 1 mt with 3 nylon hangers*

7

### Panchine spogliatoio con struttura di alluminio - Aluminium structure benches



S07352

**S07352**

Panchina spogliatoio semplice, struttura di alluminio anodizzato, lunghezza mt 2

*Locker room bench, aluminium structure, length 2 mt*

**S07354**

Panchina spogliatoio semplice, struttura di alluminio anodizzato, lunghezza mt 1

*Locker room bench, aluminium structure, length 1 mt*



S07356

**S07356**

Panchina spogliatoio con schienale, struttura di alluminio anodizzato, lunghezza mt 2

*Locker room bench with backrest, aluminium structure, length 2 mt*

**S07358**

Panchina spogliatoio con schienale, struttura di alluminio anodizzato, lunghezza mt 1

*Locker room bench with backrest, aluminium structure, length 1 mt*



S07360

**S07360**

Panchina spogliatoio completa, struttura di alluminio anodizzato, lunghezza mt 2

*Complete locker room bench, aluminium structure, length 2 mt*

**S07362**

Panchina spogliatoio completa, struttura di alluminio anodizzato, lunghezza mt 1

*Complete locker room bench, aluminium structure, length 1 mt*

**S07364**

Panchina per spogliatoio completa, ad isola, per posizionamento a centro locale, struttura di alluminio anodizzato, lunghezza mt 2

*Double side complete locker room bench, aluminium structure, length 2 mt*

**S07366**

Panchina per spogliatoio completa, ad isola, per posizionamento a centro locale, struttura di alluminio anodizzato, lunghezza mt 1

*Double side complete locker room bench, aluminium structure, length 1 mt*

**S07368**

Attaccapanni con porta borse da fissare a parete, struttura di alluminio, lunghezza mt 2 con 6 grucce di plastica

*Clothes hanger rail with bags support to be fixed to the wall, aluminium structure, length 2 mt with 6 plastic hangers*

**S07370**

Attaccapanni con porta borse da fissare a parete, struttura di alluminio, lunghezza mt 1 con 3 grucce di plastica

*Clothes hanger rail with bags support to be fixed to the wall, aluminium structure, length 1 mt with 3 plastic hangers*

**S07372**

Tavola attaccapanni di alluminio da fissare a parete, lunghezza mt 2 con 6 grucce di plastica

*Aluminium clothes hanger rail to be fixed to the wall, length 2 mt with 6 plastic hangers*

**S07374**

Tavola attaccapanni di alluminio da fissare a parete, lunghezza mt 1 con 3 grucce di plastica

*Aluminium clothes hanger rail to be fixed to the wall, length 1 mt with 3 plastic hangers*

8

### Accessori per spogliatoio Accessories for locker room

**S07404**

Pedana poggiapiedi di legno con piedini gommati, lunghezza mt 2

*Wooden footrest with rubber feet, length 2 mt*

**S07406**

Pedana poggiapiedi di legno con piedini gommati, lunghezza mt 1

*Wooden footrest with rubber feet, length of 1 mt*

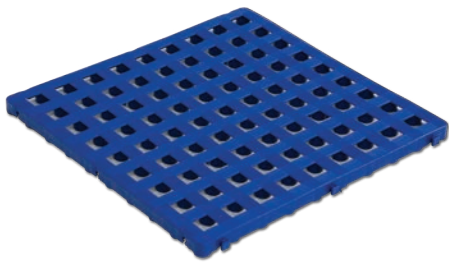

S07408

**S07408**

Modulo pedana poggiapiedi di plastica  
agganciabile, dimensioni cm 50x50  
*Attachable plastic footrest element,  
dimensions 50x50 cm*



S07410

**S07410**

Tavolo per massaggi, struttura di acciaio verniciato, piano imbottito  
e rivestito  
*Massage couch, varnished steel structure, padded and coated surface*



S07412

**S07412**

Tavolo per spogliatoio, struttura di  
acciaio verniciato, dimensioni cm  
80x80x76  
*Locker room table, varnished steel  
structure, dimensions 80x80x76 cm*



S07414

**S07414**

Sedia di acciaio cromato con scocca di  
polipropilene colorato  
*Chromed steel chair with coloured  
polypropylene seat*



S07416

**S07416**

Bacheca con struttura di alluminio  
anodizzato, dimensioni cm 120x90  
*Wall mounted notice board with  
aluminium structure, dimensions 120x90  
cm*



S07418

**S07418**

Porta ombrelli di acciaio verniciato  
*Varnished steel umbrella stand*



S07420

**S07420**

Porta rifiuti di plastica colorata  
*Coloured plastic trashcan*

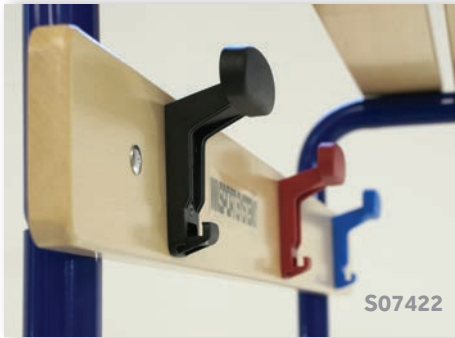

**S07422**  
 Appendiabiti di nylon colorato per tavola attaccapanni  
*Coloured nylon single clothes hanger for hanger plank*



**S07434**  
 Graticcio per doccia di legno con piedini gommati, dimensioni cm 60x60  
*Wooden shower grid with rubber feet, dimensions 60x60 cm*



**S07440**  
 Distributore di sapone liquido di acciaio da fissare a parete  
*Stainless steel liquid soap dispenser to be fixed to the wall*



**S07424**  
 Appendiabiti singolo di plastica da fissare a parete  
*Plastic clothes hanger to be fixed to the wall*



**S07436**  
 Porta saponetta di plastica da fissare a parete  
*Plastic soap support to be fixed to the wall*

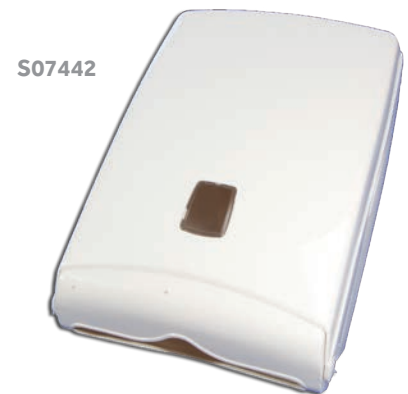

**S07442**  
 Distributore di salviette di plastica da fissare a parete  
*Plastic hand towel dispenser to be fixed to the wall*

**S07426**  
 Appendiabiti singolo di acciaio da fissare a parete  
*Steel clothes hanger to be fixed to the wall*



**S07437**  
 Porta saponetta di acciaio da fissare a parete  
*Stainless steel soap support to be fixed to the wall*

**S07428**  
 Divisorio per doccia con supporto di acciaio inox e pannello di laminato  
*Shower partition in stainless steel complete with hpl wall*

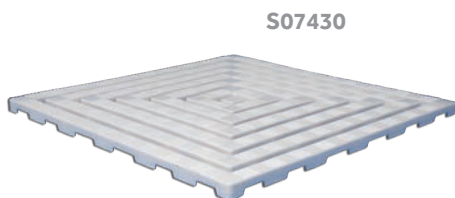

**S07430**  
 Graticcio per doccia di plastica, dimensioni cm 60x60  
*Plastic shower grid, dimensions 60x60 cm*



**S07438**  
 Distributore di sapone liquido di plastica da fissare a parete  
*Plastic liquid soap dispenser to be fixed to the wall*

#### NOTE

Le immagini degli accessori per spogliatoio dall'articolo **S07424** al **S07482** sono indicative.

*Images of locker room's accessories from article **S07424** to **S07482** are indicatives.*



S07444

**S07444**

Distributore di salviette di acciaio da fissare a parete  
*Stainless steel hand towel dispenser to be fixed to the wall*



S07452

**S07452**

Specchio a parete basculante per disabili  
*Reclining wall mirror for disabled people*

**S07462**

Asciugacapelli elettrico con temporizzatore, scocca di plastica  
*Hair dryer with plastic shell*



S07464

**S07464**

Asciugacapelli elettrico con temporizzatore e tubo flessibile, scocca di alluminio  
*Hair dryer with aluminium shell, equipped with flexible tube*

S07446

**S07446**

Confezione di salviette di carta  
*Package of paper hand towels*

**S07456**

Mensola di vetro e metallo per specchio, lunghezza cm 60  
*Glass and steel shelf for mirror, length 60 cm*

S07458

**S07458**

Asciugamani elettrico con temporizzatore, scocca di plastica  
*Hand dryer with plastic shell*

S07466

**S07466**

Asciugacapelli elettrico con temporizzatore e tubo flessibile, scocca di plastica  
*Hair dryer with plastic shell, equipped with flexible tube*



S07448

**S07448**

Specchio a parete con cornice, diametro cm 50  
*Wall mirror with plastic frame, diameter 50 cm*

**S07460**

Asciugamani elettrico con temporizzatore, scocca di alluminio  
*Hand dryer with aluminium shell*



S07462

S07468

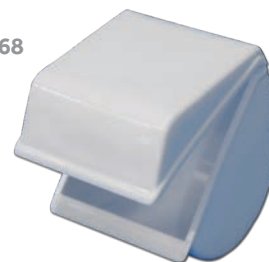
**S07468**

Porta rotolo carta igienica di plastica da fissare a parete  
*Plastic toilet paper roll holder to be fixed to the wall*



S07470

**S07470**

Porta rotolo carta igienica di acciaio da fissare a parete

*Stainless steel toilet paper roll holder to be fixed to the wall*

S07472

**S07472**

Porta rotolo carta igienica maxi di plastica da fissare a parete

*Maxi model plastic toilet paper roll holder to be fixed to the wall*

S07474

**S07474**

Porta rotolo carta igienica maxi di acciaio da fissare a parete

*Maxi model stainless steel toilet paper roll holder to be fixed to the wall*

S07476

**S07476**

Scopino per wc con porta scopino di plastica

*Wc toilet brush cleaner with plastic support*

S07478

**S07478**

Scopino per wc con porta scopino di acciaio

*Wc toilet brush cleaner with stainless steel support*

S07480

**S07480**

Porta sacchetti igienici femminili, di acciaio da fissare a parete

*Female hygienic bags steel dispenser to be fixed to the wall*

S07482

**S07482**

Cestino di plastica raccogli sacchetti igienici femminili

*Female hygienic bags plastic trash can*

9

## Protezioni murali e bordo campo

### Wall and boundary protections

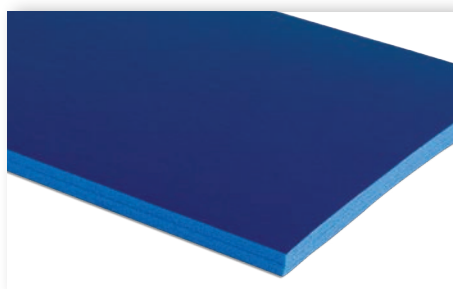
**S07502**

Protezione murale di polietilene ad alta densità, superficie di PVC, spessore mm 22, altezza cm 200, ignifuga e a norma EN913

*Wall protection made of high density polyethylene covered with PVC, thickness 22 mm, height 200 cm, fireproof and EN913 tested*

**S07503**

Protezione murale di polietilene con superficie in PVC per uso esterno, spessore mm 20, altezza cm 200, a norma EN913

*Wall protection for outdoor use made of polyethylene covered with PVC, thickness 20 mm, height 200 cm, EN913 tested*

**S07504**

Protezione per colonna di polietilene ad alta densità, superficie di PVC, spessore mm 22, altezza cm 200, ignifuga e a norma EN913

*Column protection made of high density polyethylene covered with PVC, thickness 22 mm, height 200 cm, fireproof and EN913 tested*

**S07505**

Protezione per colonna di polietilene con superficie in PVC per uso esterno, spessore mm 20, altezza cm 200, a norma EN913

*Column protection for outdoor use made of polyethylene covered with PVC, thickness 20 mm, height 200 cm, EN913 tested*

**S07506**

Protezione murale di gomma espansa completamente rivestita di PVC, banda occhiellata o Velcro per fissaggio, spessore mm 40

*Wall protection made of high density foam fully covered with PVC, upper strip with steel rings or Velcro for easy fixing to the wall, thickness 40 mm*

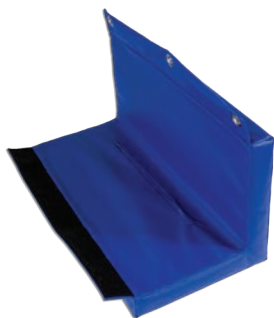
**S07508**

Protezione per colonna di gomma espansa rivestita di PVC, banda occhiellata o Velcro per fissaggio, spessore mm 40

*Column protection made of high density foam covered with PVC, upper strip with steel rings or Velcro for easy fixing to the wall, thickness 40 mm*

**S07510**

Protezione ONDA per parete e colonne in Polymat ignifugo e a norma EN913 per uso interno ed esterno, dimensioni cm 200x100

*ONDA model wall and column protection made in fireproof and EN913 tested Polymat for indoor and outdoor use, dimensions 200x100 cm*

**S07511**

Protezione parasigoli in polietilene espanso ignifugo, spessore mm 10, larghezza cm 5+5, altezza cm 200

*Corners protection made of fireproof polyethylene foam, thickness 10 mm, element of 5+5 cm, height 200 cm*

**S07514**

Protezione parasigoli per esterno in granuli di gomma EPDM, spessore mm 25, larghezza cm 10+10, lunghezza cm 98

*Outdoor corners protection made of rubber granules EPDM, thickness 25 mm, element of 10+10 cm, length 98 cm*

**S07516**

Protezione parasigoli per esterno in gomma espansa spessore mm 25 con superficie in erba sintetica, larghezza cm 10+10, lunghezza cm 100

*Outdoor corners protection made of foam thickness 25 mm covered artificial grass, element of 10+10 cm, length 100 cm*

**S07517**

Colla per applicazione di protezioni murali e parasigoli, in barattolo  
*Glue specific for application of wall and corners protection, supplied in can*

**S07518**

Elementi di separazione e protezione bordo campo in gomma espansa rivestita di PVC ignifugo, sezione triangolare, base cm 200x50, altezza cm 75  
*Boundary protective pad for play court made of high density foam fully covered with fireproof PVC, triangular section with base 200x50 cm and height 75 cm*



esempio di utilizzo S07518 - example of use for S07518

**NOTE**

Elementi di separazione **S07518** personalizzabili nel colore del PVC e nelle dimensioni, a richiesta; utili per supportare banner promozionali facilmente applicabili con Velcro o uso di bandella occhiellata.

*Boundary protective pad **S07518** can be customized on PVC's color and dimensions, on demand; useful for supporting promotional banner easily applicable by means of Velcro or eyelet belt.*

10

## Reti divisorie e di protezione - *Dividing and boundary nets*

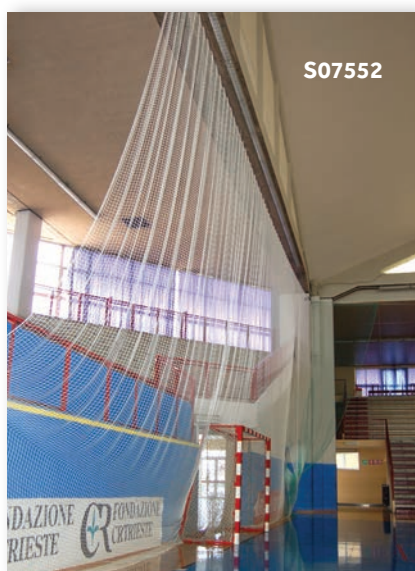

S07552

**S07552**

Rete divisoria e di protezione per uso interno in nylon ignifugo, diametro mm 3, maglia cm 10x10  
*Protective and dividing net made of fireproof nylon, diameter 3 mm, mesh 10x10 cm*



S07554

**S07554**

Rete divisoria e di protezione per uso interno in nylon ignifugo, diametro mm 3, maglia cm 4,2x4,2  
*Protective and dividing net made of fireproof nylon, diameter 3 mm, mesh 4.2x4.2 cm*



**S07556**  
Bordatura perimetrale per rete divisoria e di protezione  
*Bording cord for protective and dividing net*



**S07558**  
Cavo in acciaio per sostegno rete divisoria e di protezione  
*Steel wire supporting protective and dividing net*



**S07560**  
Tenditore per cavo in acciaio  
*Steel tensioner for wire supporting protective and dividing net*



**S07562**  
Anello in acciaio per scorrimento rete su cavo  
*Steel fixing hook for net*

11

**Tende e pannelli divisori - Dividing curtains and panels**

REFERENZE

REFERENCES

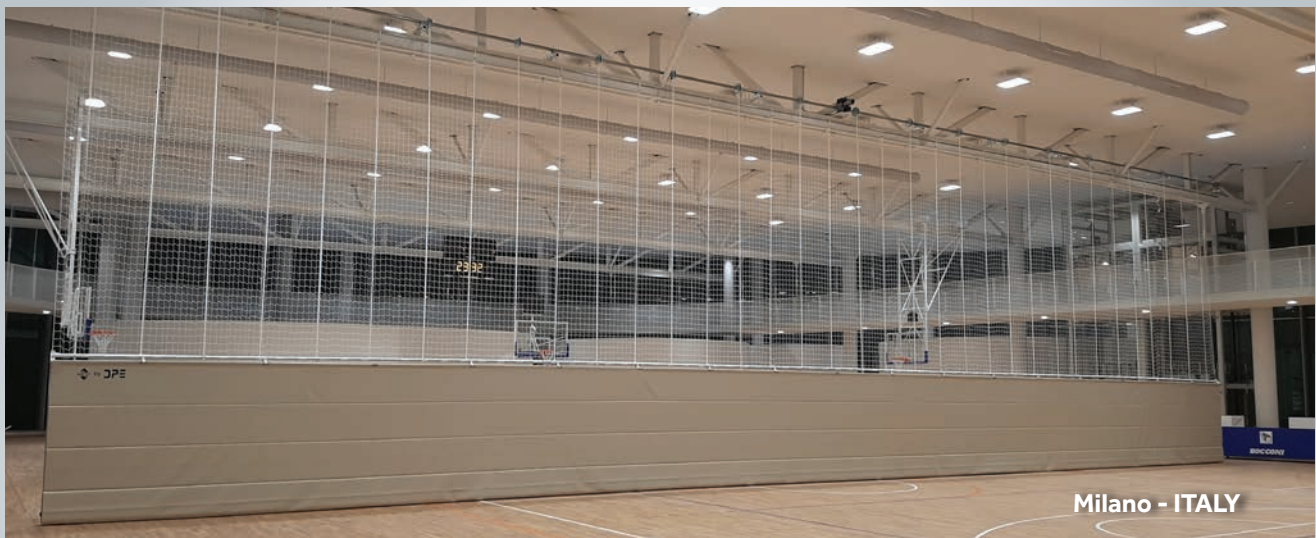

Milano - ITALY

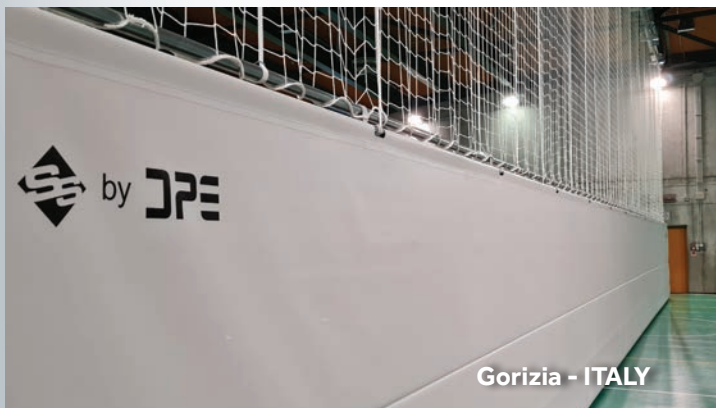

Gorizia - ITALY

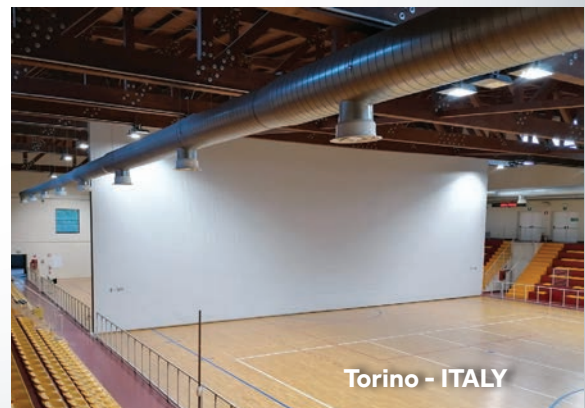

Torino - ITALY

**S07601**

Tenda divisoria combinata roll-up per campi gioco realizzata in materiale sintetico ignifugo a singolo telo per cm 270 da terra e "mesh" per la restante altezza, funzionamento elettrico. Chiusura compatta in soli 40 cm

*Play-courts combined dividing roll-up curtain made of synthetic fireproof PVC, single layer, for 270 cm on bottom part and mesh on upper side, closing to the ceiling by electric motor. Compact closure in just 40 cm*

**S07602**

Tenda divisoria "acustica" per campi da gioco realizzata in materiale sintetico ignifugo a doppio telo, scorrimento verticale con funzionamento elettrico

*Play-courts "acoustic" dividing curtain made of synthetic fireproof PVC, double layer, closing to the ceiling by electric motor*

**S07603**

Tenda divisoria combinata per campi gioco realizzata in materiale sintetico ignifugo a singolo telo per cm 270 da terra e rete a maglia cm 10x10 per la restante altezza, scorrimento verticale con funzionamento elettrico

*Play-courts combined dividing curtain made of synthetic fireproof PVC, single layer, for 270 cm on bottom part and 10x10 cm net on upper side, closing to the ceiling by electric motor*

**S07604**

Tenda divisoria combinata per campi gioco realizzata in materiale sintetico ignifugo a doppio telo per cm 220 da terra e rete a maglia cm 10x10 per la restante altezza, scorrimento verticale con funzionamento elettrico

*Play-courts combined dividing curtain made of synthetic fireproof PVC, double layer, for 220 cm on bottom part and 10x10 cm net on upper side, closing to the ceiling by electric motor*



**S07606**

Rete divisoria e di protezione per campi gioco a maglia cm 10x10 per tutta l'altezza, scorrimento verticale con funzionamento elettrico

*Play-courts dividing and protective netting, mesh 10x10 cm, for the whole height, closing to the ceiling by electric motor*

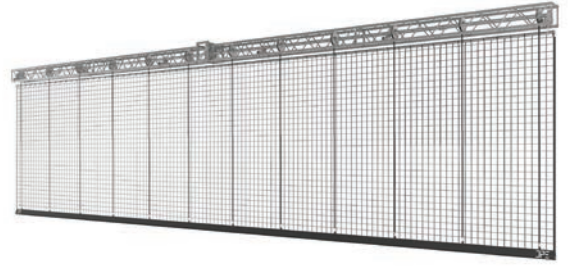
**S07610**

Rete divisoria e di protezione per campi gioco a maglia cm 10x10 per tutta l'altezza, scorrimento manuale su binario

*Play-courts dividing and protective netting, mesh 10x10 cm, for the whole height, manually closing to the side on rail*

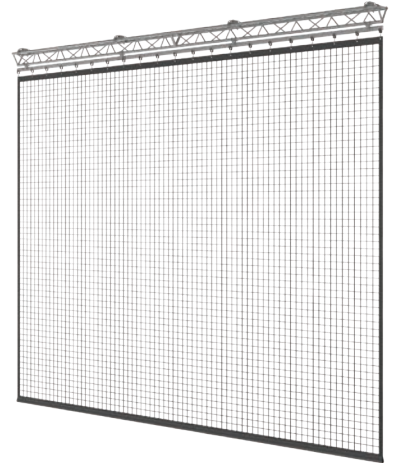
**S07611**

Tenda divisoria per campi da gioco realizzata in materiale sintetico ignifugo a singolo telo, scorrimento manuale su binario

*Play-courts dividing curtain made of synthetic fireproof PVC, single layer, manually closing to the side on rail*

**S07612**

Tenda divisoria per campi da gioco realizzata in tessuto ignifugo a singolo telo, scorrimento manuale su binario

*Play-courts dividing curtain made of fireproof fabric, manually closing to the side on rail*



**S07613**

Tenda divisoria combinata per campi gioco realizzata in materiale sintetico ignifugo a singolo telo per cm 270 da terra e rete a maglia cm 10x10 per la restante altezza, scorrimento manuale su binario

*Play-courts combined dividing curtain made of synthetic fireproof PVC, single layer, for 270 cm on bottom part and 10x10 cm net on upper side, manually closing to the side on rail*

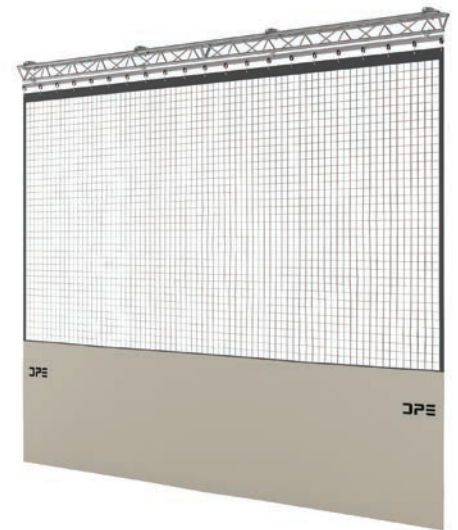
**REFERENZE**

Bolzano - ITALY



Caorle - ITALY



Oyrabakki - FAROE ISLANDS

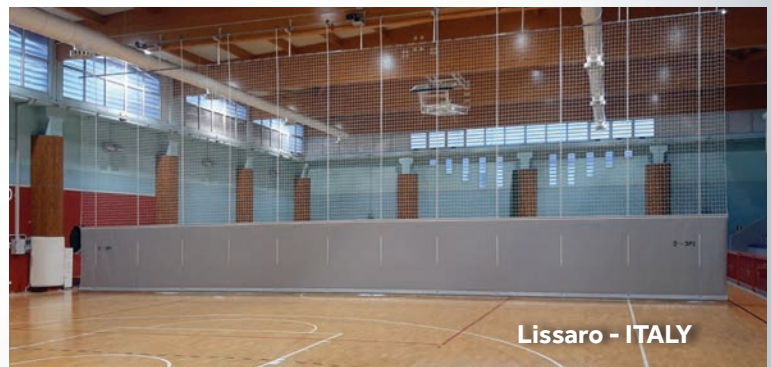

Lissaro - ITALY

**S07620**

Pannello divisorio in PVC colorato su struttura di supporto in acciaio verniciato e zincato con sistema telescopico di regolazione dell'altezza, mobile su ruote (con freno), lunghezza cm 300 ed altezza massima cm 220

*Colored PVC dividing panel with varnished and galvanized steel structure telescopically adjustable in height, mobile on wheels (with brake), length 300 cm with maximum height 220 cm*



S07620

13

## Tribune fisse, telescopiche e trasportabili - Fixed, telescopic and portable stands



S07652 + S07654 + S07656



S07652 + S07654 + S07656

**S07652**

Tribuna fissa per interni con struttura di acciaio verniciato, piani seduta di legno o a scocche di polipropilene, corridoi e scale di accesso secondo normativa corrente; personalizzabile a richiesta nei particolari

*Fixed grandstand for indoor use with varnished steel structure, seating area made of wood or coloured polypropylene seats, walkways and stairways accordingly to current rules; can be customized on demand*

**S07654**

Parapetto laterale in acciaio verniciato per tribuna S07652  
*Lateral hand rails made of varnished steel for grandstand S07652*

**S07656**

Parapetto posteriore in acciaio verniciato per tribuna S07652  
*Back hand rail made of varnished steel for grandstand S07652*



S07652 + S07654



S07652 + S07654

**NOTE**

**Tribuna S07652** personalizzabile nella scelta cromatica, nell'allestimento e nelle finiture: seduta di legno o a scocche di polipropilene con o senza schienale ... pannelli di camminata in legno antiscivolo, in acciaio grigliato o alluminio ... eventuale tamponamento frontale e laterale in legno o alluminio ...

**Grandstand S07652** can be customized with a range of colours. Fittings and finishing: seating elements in wood or colored polypropylene seats with or without backrest ... walkways with non-slip surfaces or steel grill or aluminum surface ... eventual vertical closing panels in wood or aluminum ...

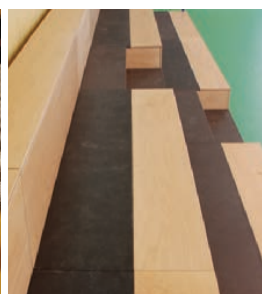





S07658 + S07660 + S07662

**S07658**

Tribuna fissa per esterno con struttura di acciaio zincato, sedute in polipropilene, corridoi e scale di accesso secondo normativa corrente

*Fixed grandstand for outdoor use with galvanized steel structure, coloured polypropylene seats, walkway and stairway accordingly to current rules*

**S07660**

Parapetto laterale in acciaio zincato per tribuna S07658  
*Lateral hand rails made of galvanized steel for grandstand S07658*

**S07662**

Parapetto posteriore in acciaio zincato per tribuna S07658  
*Back hand rail made of galvanized steel for grandstand S07658*

**Tribuna S07658** personalizzabile a richiesta nell'allestimento e nelle finiture. In foto tribuna a 3 gradoni con sedute ribaltabili in polipropilene, modello S07694.

**Grandstand S07658** can be customized on demand on fittings and finishing. Side pictures are showing a 3 steps grandstand equipped with tip-up polypropylene seats, model S07694.

**NOTE**

COSTA RICA

**S07664**

Tribuna telescopica per interni a movimentazione manuale o elettrica, struttura di acciaio verniciato, piani di seduta di legno o a scocche di polipropilene, corridoi, scale e parapetti secondo normativa corrente, totalmente personalizzabili nelle dimensioni e nelle finiture

*Telescopic grandstand for indoor use manually or electrically operating, varnished steel structure, seating area made of wood or coloured polypropylene seats, walkways, stairways and hand rails accordingly to current rules, entirely customizable on dimensions fittings and finishing*



S07666

**S07666**

Tribuna VIP componibile e trasportabile realizzabile mediante affiancamento di moduli seduta e moduli scala; ciascun modulo con struttura in acciaio verniciato, piani di calpestio in legno trattato con finitura antiscivolo e ruote gommatae installate in modo da permettere l'agevole spostamento del modulo una volta ribaltato. Il modulo seduta consta di nr 6 poltrone VIP, personalizzabili nei colori, modello Master Mini 28 con sedile tip-up, distribuite su 3 gradoni. Il modulo scala consta di 2 scalini di accesso e 2 sedute del modello succitato disposte sul gradone più alto

*VIP modular and portable grandstand to be realized by alternation of different quantities of seating and step modules; each module is made of epoxy painted steel construction, is equipped with walkways made of special non-slip finished wooden panels and rubberized wheels useful for rolling away the module itself once tipped-up on side. Seating module is equipped with 6 VIP tip-up armchairs model Master Mini 28 distributed in 3 steps. The steps module has 2 access step and 2 VIP seats on the top level*



S07668

**S07668**

Modulo tribuna da mt 2 a 3 file di seduta con 12 scocche di polipropilene colorato su struttura in acciaio verniciato (colore a richiesta), ribaltabile e mobile su ruote per stoccaggio  
*Compact stand for indoor use 2 mt with 3 steps and 12 coloured polypropylene seats mounted onto varnished steel structure (color on demand), foldable and mobile on wheels for storing*

**S07669**

Modulo scala con larghezza cm 120 per tribune mobili da interno S07668 e S07672  
*Stairway module 120 cm width for portable indoor stands S07668 and S07672*



S07670

**S07670**

Modulo tribuna da mt 2 a 3 file di seduta con 12 scocche di polipropilene colorato su struttura in acciaio zincato, per uso interno ed esterno, ribaltabile e mobile su ruote per stoccaggio

*Compact stand for indoor and outdoor use 2 mt with 3 steps and 12 polypropylene seats mounted onto galvanized steel structure, foldable and mobile on wheels for storing*

**S07671**

Modulo scala con larghezza cm 120 per tribune mobili da esterno S07670

*Stairway module 120 cm width for portable outdoor stands S07670*



S07672

**S07672**

Modulo tribuna da mt 2 a 3 file di seduta a pannelli di legno su struttura in acciaio verniciato (colore a richiesta), ribaltabile e mobile su ruote per stoccaggio

*Compact stand for indoor use 2 mt with 3 steps and wooden seating area mounted onto varnished steel structure (color on demand), foldable and mobile on wheels for storing*



S07678

**S07678**

Tribuna componibile da mt 10 costituita di 4 moduli di seduta più un modulo con scalini di accesso, accostabili tra loro secondo qualsiasi ordine, ribaltabili e mobili su ruote, stoccabili a scomparsa uno nell'altro grazie alla diversa lunghezza dei moduli stessi (cm 280, 240, 200, 160 e 120); struttura in acciaio verniciato (colore a richiesta), pannelli di seduta in legno verniciato, pannelli di camminata in legno con finitura antiscivolo; poggia-schiena abbattibile integrato nell'ultima fila di seduta; per uso interno

*Portable stackable grandstand with total length of 10 mt made of 4 seating modules and one module with access steps that can alternate in any different positions; each module can be tipped-up and rolled away on proper wheels installed on back side of structure; different modules can be stocked on wheels one inside the others thanks to the different length (280, 240, 200, 160 and 120 cm); varnished steel structure (color on demand), varnished wooden panels on seating area, anti-slip surface wooden panels on walking area and steps; foldable backrest on last seating row; for indoor use*

**S07679**

Tribuna componibile da mt 10 come articolo S07678, con struttura in acciaio zincato e pannelli di seduta e camminata realizzati in legno trattato per uso esterno

*Portable stackable grandstand with total length of 10 mt as article S07678, galvanized steel structure and wooden panels on seating and walking areas specially treated for outdoor use*



S07679

FOTO DEL MODULO DA CM 200  
PICTURE OF 200 CM MODULE

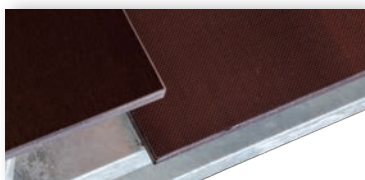



S07680

**S07680**

Modulo tribuna per esterno completamente in acciaio zincato con scalino di accesso e 2 file di sedute a scocche di polipropilene per un totale di 7 posti

*Compact stand for outdoor use entirely made in galvanized steel with stairway and walkway, 2 steps with total 7 places equipped with polypropylene seats*

**S07682**

Modulo tribuna per esterno in acciaio zincato e verniciato con scalino di accesso e 2 file di sedute a scocche di polipropilene per un totale di 7 posti, con personalizzazione 3ON3 (vedi pagina 139)

*Compact stand for outdoor use entirely made in galvanized and varnished steel with stairway and walkway, 2 steps with total 7 places equipped with polypropylene seats, customized 3ON3 (refer to page 139)*



S07682

**S07684**

Copertura per gradoni tribuna realizzata in tavole di legno verniciato con trattamento ignifugo

*Cover for stand's steps made of fireproof varnished wooden panels*



S07684

## Scocche e sedute vip - Polypropylene and vip seats

**S07690**

Scocca di seduta senza schienale in polipropilene ignifugo colorato, fissaggio diretto al gradone  
*Fireproof colored polypropylene seat without backrest, to be directly fixed to concrete step*

**S07692**

Scocca di seduta con schienale in polipropilene ignifugo colorato, fissaggio diretto al gradone  
*Fireproof colored polypropylene seat with backrest, to be directly fixed to concrete step*

**S07694**

Scocca di seduta ribaltabile con sedile e schienale in polipropilene colorato ignifugo, montati su telaio in poliammide per fissaggio fronte gradone  
*Tip-up seat with seating and backrest elements in colored fireproof polypropylene mounted on polyamide structure that can be riser fixed to concrete step*

**NOTE**

Articoli **S07690, S07692, S07694** disponibili in vari colori, per informazioni sulla disponibilità: [info@sportssystem.it](mailto:info@sportssystem.it)

Articles **S07690, S07692, S07694** available in different colors, for info about availability: [info@sportssystem.it](mailto:info@sportssystem.it)

**S07696**

Poltrona VIP per gradinate di stadi e palazzi dello sport disponibile in vari modelli marchiati "Sport System by Lino Sonogo", tutti personalizzabili a richiesta nella scelta dei colori e con il ricamo di eventuali loghi  
*VIP armchair for football stadium and indoor sport halls' stands available in different models branded "Sport System by Lino Sonogo", all of them customizable on colors selection and by embroidering any logos*

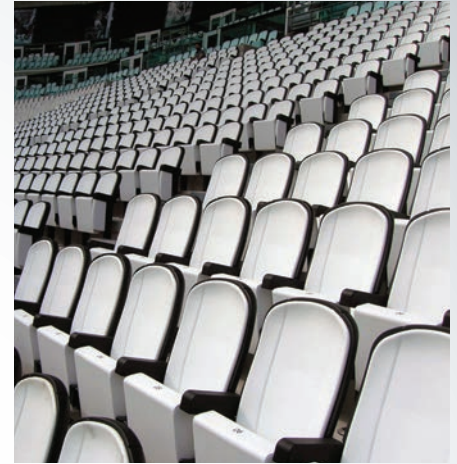

### SEDUTE VIP "SPORT SYSTEM BY LINO SONEGO"

Sport System arreda con stile ed eleganza le gradinate VIP di stadi outdoor ed arene indoor con oltre 10 diversi modelli di poltrone totalmente personalizzabili. Per maggiori informazioni e per richiedere un preventivo contattare [info@sportssystem.it](mailto:info@sportssystem.it)



### VIP ARMCHAIRS "SPORT SYSTEM BY LINO SONEGO"

Sport System equipa con stile ed eleganza le VIP areas of main outdoor stadium and indoor sports arenas with more than 10 different models of armchairs totally customizable. For more info and to require an offer contact [info@sportssystem.it](mailto:info@sportssystem.it)



## Transenne e sistemi di pulizia - *Barriers and cleaning tools*



### S07700

Transenna di acciaio zincato con piedi di appoggio a terra, dimensioni cm 200x100, con sistema di aggancio a catena  
*Tubular galvanized steel barrier 200x100 cm, free standing model, with connection joints*



### S07710

Transenna in plastica con piedi di appoggio a terra ruotabili, dimensioni cm 215x90, con banda catarifrangente, con sistema di aggancio a catena  
*Plastic barrier with pivoting feet, dimensions 215x90 cm, with reflecting adhesive band and connection joints*



### S07712

Transenna divisoria per palestre realizzata in acciaio verniciato, dimensioni indicative del singolo elemento cm 200x100, disponibile nella soluzione a bussole o con piastre da tassellare a pavimento; personalizzabile  
*Dividing barrier for indoor sport hall made in varnished steel, indicative dimensions of each element 200x100 cm, available in sockets solution or with ground fixing plates; can be customized*



### S07713

Sistema di protezione per transenna divisoria realizzato con elementi sagomati di gomma espansa, rivestiti in PVC colorato  
*Shaped protective pad modules for dividing barrier made of soft foam covered in PVC*





S07715

**S07715**

Spazzolone per pulizia ed asciugatura area pubblico e campo di gioco

*Scrubber for cleaning spectators' area and playcourt*

LINK



Inquadra il QR Code di sinistra col tuo cellulare per accedere alla sezione Arredi del sito [www.sportssystem.it](http://www.sportssystem.it)

Scan the QR Code at your right with your mobile phone to navigate the Furniture section at [www.sportssystem.it](http://www.sportssystem.it) site

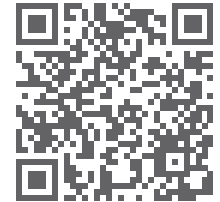
**S07720**

Macchina motospazzatrice "uomo a bordo" per tutte le superfici, funzionante con batteria ricaricabile

*Ride-on vacuum sweeper for all type of surfaces, working with rechargeable battery*

**S07725**

Macchina lavasciuga pavimenti manuale, funzionante con batteria ricaricabile

*Manual washing machine working with rechargeable battery*







L'AZIENDA

ALCUNE  
REFERENZE

COMPANY  
PROFILE

SOME  
REFERENCES



**SPORT SYSTEM** WWW.SPORTSYSTEM.IT Dal 1979 Sport System progetta, produce, distribuisce ed installa, in Italia e nel resto del mondo, una **vasta gamma di attrezzature ed articoli sportivi per la ginnastica, l'atletica, gli sport individuali e di squadra**. La **qualità dei materiali** utilizzati, il **design degli articoli progettati e prodotti**, il **rispetto delle norme di sicurezza** e dei regolamenti tecnici internazionali di ogni singolo sport, il servizio pre e post vendita garantiscono la massima soddisfazione tanto delle richieste del cliente istituzionale quanto dei bisogni del sempre più esigente atleta professionista. L'ampia offerta di **Sport System** comprende altresì una linea articolata e completa di **arredi ed accessori** per i vari locali annessi all'area di gioco quali **spogliatoi, infermerie, sale stampa e sale riunioni, tribune e gradinate**. Tutto questo, oltre alla possibilità di personalizzare qualsiasi articolo secondo le esigenze del cliente, permette all'azienda di offrire ai propri interlocutori la possibilità di arredare qualsiasi struttura sportiva nella sua interezza e secondo le più svariate necessità. Nella continua tensione ad una costante soddisfazione dei propri clienti **Sport System** è stata la prima azienda italiana del settore ad aver implementato un sistema qualità aziendale ed è attualmente in possesso della certificazione di qualità secondo la norma **UNI EN ISO 9001/2015**.

Da sempre specializzata nella produzione di innovativi impianti basket omologati per competizioni internazionali, forte di **oltre 40 anni di esperienza** pratica e progettuale, **Sport System è partner del FIBA "Equipment & Venue" Centre** (già "FIBA Research & Study Centre") e fornitrice delle più prestigiose squadre di basket italiane ed estere. Gli impianti basket di Sport System sono già stati utilizzati in occasione di molteplici eventi internazionali organizzati da FIBA, sia in Italia che nel resto del mondo.

Da oltre 20 anni il marchio **Sport System** è presente anche nei principali stadi internazionali dove sono state installate le **panchine VIP** personalizzate per riserve ed allenatori riconoscibili dal design e lo stile tipicamente italiani e dall'elevata cura dei particolari.

Recentemente l'offerta è stata ampliata con l'introduzione di una linea di sistemi di **suddivisione degli spazi** (conosciuti anche con il termine di **tende divisorie**), sia manuali che motorizzati, sempre più richiesti al fine di garantire la divisione degli ambienti ed il rispetto del distanziamento tra gli utilizzatori di una stessa struttura.

Maggiori informazioni relativamente all'azienda, alla propria offerta e alle referenze conseguite si possono acquisire visitando il **sito internet aziendale [www.sportsystem.it](http://www.sportsystem.it)** ed in particolare la pagina **referenze** e la pagina **pubblicazioni** dalla quale sono scaricabili il file pdf del catalogo aggiornato, della lista referenze, di alcuni dépliant e altri utili documenti.



**SPORTSYSTEM** WWW.SPORTSYSTEM.IT Since 1979 Sport System has been designing, manufacturing, trading and installing, in Italy and internationally, a wide range of gym and fitness accessories and sports equipment for gymnastics, athletics, individual and team sports. The quality of materials used, the design of equipment produced, the respect of each sports single technical requirements, the service provided both before and after sales, has all been helping Sport System to achieve both the requirements of institutional customers as well as the needs of the more sophisticated professional sportsmen. The wide Sport System's catalogue also includes a complete range of furnishing and accessories for spectator's areas, changing rooms, infirmaries, meeting and press rooms allowing customers to completely equip an entire sport complex. Always focusing on customer satisfaction, Sport System has been the first Italian company in this sector to implement a high quality system that is now certified according to **UNI EN ISO 9001/2015**.

Specialized in basketball and with more than 40 years of experience in designing and manufacturing top quality professional basketball backstops approved for International competition, Sport System is a FIBA "Equipment & Venue" (former "FIBA Research & Study Centre") partner as well as the official supplier of some of the most prestigious basketball clubs and basketball arenas worldwide. Having reached a leadership position in the world market of sport equipments and with the consolidation of its own trademark among the leading international suppliers of basketball equipment, not only represent for Sport System an important acknowledgement but is the recognition of the efforts and continuous commitment to improve the products and services offered.

For more than 20 years the Sport System's brand has also proved popular for major International soccer stadiums where the customized VIP team shelters have been installed and are easily recognizable by the finest Italian design and style as well as the high attention to detail.

During a time where the division of spaces and social distancing between people are important factors in the management of sport facilities, Sport System presents a new line of dividing curtains that is in constant evolution and expansion to fit requirements of any different sports facility.

For more info and news about company and its offer, the company's website [www.sportssystem.it](http://www.sportssystem.it) is available and constantly updated.



ŠIRVINTOS - LITHUANIA



MAZZANO - ITALY



VARESE - ITALY

**AUSTRALIA** Adelaide - Coopers Arena ::: Adelaide - Shores Football Centre ::: Broadbeach - Gold Coast Convention & Exhibition Centre ::: Perth - Perth Arena ::: Victoria - Geelong Arena | **AUSTRIA** Klagenfurt - United World Games 2019 | **AZERBAIJAN** Baku - Central Stadium Tofik Bakhranov ::: Baku - Central School N 134 | **BELARUS** Minsk - Palova Arena ::: Pinsk - Volna Arena | **BELGIUM** Brussels - Palais 12 - Brussels Expo ::: Charleroi - Spiroudome ::: Merksem - Lotto Arena ::: Oostende - Versluys Dôme | **BOLIVIA** Sucre - Estadium Olimpico Patria ::: Tarija - Gran Guadalquivir Basquetbol | **BOSNIA HERZEGOVINA** Banja Luka - Gradski-Stadion ::: Laktasi - Laktasi Sport Hall ::: Mostar - F.C. Zrinjski Stadium ::: Zenica - Stadion Bilino Polje ::: Zenica - Zenica Arena | **BULGARIA** Pleven - Balkanstroy Sport Hall ::: Samokov - Samokov Arena ::: Sofia - 3X3 Court | **CANADA** Calgary - Talisman Centre ::: Waterloo - Physical Activities Complex - University of Waterloo | **COSTA RICA** Cartago - Colegio Miravalle ::: Limon - University of Costa Rica | **CROATIA** Osijek - Dvorana Gradski VRT Osijek ::: Pula - Gradski Stadion Aldo Drosina ::: Rijeka - Kantrida Stadium ::: Zara - Zara Municipal Sport Hall | **CYPRUS** Limassol - Melford Arena ::: Limassol - Multifunctional Sea Park (OPAP Limassol 3ON3 2019) ::: Nicosia - Achilleas Kaimakliou Sport Hall | **CZECH REPUBLIC** Opava - BK Opava Multipurpose hall ::: Pardubice - MFA Pardubice | **EGYPT** Cairo-Alexandria-Suez - Africa Cup of Nations - Egypt 2019 ::: Giza - Shooting Club Sport Hall | **ESTONIA** Rapla County - Sport Hall Kohila ::: Tartu - Le Coq Sport Hall ::: Tallin - Tallin Arena | **FINLAND** Lohja - Kisakallio Susi Training Center ::: Vantaa - Energia Hall | **FRANCE** Antibes - Sport Hall Azur ::: Lorient - Palais de Sport ::: Nancy - Palais des Sports Jean Weille ::: Villeurbanne - Astroballe | **GEORGIA** Tbilisi - Georgian Basketball Federation Sporthall ::: Tbilisi - Ministry of Defence Sporthall ::: Tbilisi - Tbilisi Challenge 3X3 | **GREECE** Athens - Peace & Friendship

Stadium ::: Crete - Heraklion arena ::: Kefalonia Island - Argostoli Sport Hall ::: Peristeri / Athens - Papandreou Hall ::: Thessaloniki - Palais de Sport' Thessaloniki | **HUNGARY** Budapest - Fiba Europe 3X3 Tour ::: Kisvárda - Kisvarda Stadium | **INDIA** New Delhi - J. Nehru Olympic Stadium | **IRAQ** Al-Kut - Al-Kut Olympic Stadium ::: Baghdad - Al Shaab Stadium ::: Baghdad - Alshuhadaa International Stadium ::: Duhok - Duhok University ::: Zakho - Zakho International Stadium | **ITALY** Bologna - Virtus Arena ::: Bologna - Palestra Porelli - Virtus Bologna ::: Bologna - LNP Coppa Italia 2017 ::: Bologna - Sport Hall Paladozza ::: Bolzano - University of Bolzano ::: Brescia - PalaLeonessa ::: Caorle - Palaexpomar ::: Cervia - Palazzetto dello Sport ::: Conegliano - Zoppas Arena ::: Cortina - Olympic Ice stadium ::: Firenze - Final Eight Coppa Italia 2018 ::: Gorizia - Palestra Istituto Cankar ::: Ischia - Forio Sport Hall ::: Jesolo - Pala Arrex ::: Leini - Cittadella dello Sport ::: Lignano - FIBA 3X3 Nations League 2019 ::: Livorno - Pala Livorno ::: Mestrino - Palestra di Lissaro ::: Milano - Allianz Cloud Arena - Palalido ::: Milano - Recreation and Sports Center - Università Bocconi ::: Montichiari - PalaGeorge ::: Napoli - Summer Universiade 2019 ::: Pesaro - Vittrifrigo Arena (Final Eight 2020 Coppa Italia) ::: Reggio Emilia - Pala Bigi ::: Riccione - Streetball Italian Tour 2018 ::: Rimini - Final Eight Coppa Italia 2017 ::: Rimini - Romeo Neri Stadium ::: San Vendemiano - PalaSport System ::: Settimo Torinese - Istituto 8 Marzo ::: Torino - Sport Hall Russel/Moro ::: Trento - Pala Trento ::: Treviso - PalaVerde Arena ::: Trieste - Allianz Dome ::: Verona - Marc'Antonio Bentegodi Stadium ::: Venezia - Taliercio Sport Hall | **JAPAN** Ohta - Ohta Citizen Gymnasium ::: Okinawa - Okinawa Sport Hall ::: Sendai - Xebio Arena | **JORDAN** Amman - Amman International Stadium ::: Amman - Prince Faisal Sport Hall ::: Amman - King Abdallah II Stadium | **KAZAKHSTAN** Astana - Saryarka Velodrome ::: Temirtau - Arcelor Mittal



ZADAR - CROATIA



ANTIBES - FRANCE



RIYADH - SAUDI ARABIA



BRESCIA - ITALY



KISVARDA - HUNGARY



LISBON - PORTUGAL



MURSKA SOBOTA - SLOVENIA

Sport Hall | **KIRIBATI** Tarawa - Betio Sports Complex | **KYRGYZ REPUBLIC** Kara-Suu Town - Gazprom FOK | **LATVIA** Riga - Fiba Europe 3X3 Tour :: Riga - Daugavas stadions :: Riga - New Riga Arena :: Saldus - Saldus Sport Hall | **LITHUANIA** Gargždai - Gargzdu miesto sporto sale :: Vilnius - Šarunas Marciulionis Basketball Academy | **MACEDONIA** Skopje - Philipp II Stadium | **MALAYSIA** Miri-Sarawak - Shin Yang Group Outdoor Basketball Court | **MAURITIUS** Côte d'Or - Multisport Complex | **MONTENEGRO** Podgorica - Podgorica City Stadium | **MOROCCO** Agadir - Stade Adrar :: Al Hoceima - Stadium Mimoun Al Arsi :: Casablanca - Stade Mohammed V :: Marrakech - Grand Stade de Marrakech :: Rabat - Complexe Sportif Prince Moulay Abdellah | **MOZAMBIQUE** Maputo - Maxaquene Stadium | **NETHERLAND** Groningen - MartiniPlaza Topsportarena :: Noordwijk - Northgo Sport Hall | **NEW ZEALAND** North Island - Arena Manawatu - :: North Island - Rotorua Events Centre | **NIGERIA** Benin City - University Of Benin Indoor Sport Hall :: Zaria - Ahmadu Bello University | **OMAN** Mana - Recreational Center :: Muscat - Nizwa Sport Complex :: Muscat - Sohar Sport Complex :: Saham - Saham Sports Club | **PANAMA** Panama City - Rommel Fernandez Stadium | **PERU** Tacna - Coliseo Peru | **POLAND** Rzeszow - Northgo Sport Hall | **PORTUGAL** Lisbon - Complexo Desportivo do Estádio Sport Lisboa e Benfica :: Oporto - Dragao Arena | **QATAR** Al Khor City - Dhakira Club :: Doha - Qatar Foundation :: Doha - Sport City-Basketball Indoor Hall | **ROMANIA** Arad - Uta Stadium :: Bucarest - Dinamo Stadium :: Bucharest - Fiba Europe 3X3 Tour :: Cluj Napoca - Cfr Stadium :: Cluji-Napoca - FIBA EuroBasket 2017 :: Crajova - Ion Oblemenco Stadium :: Iasi - Emil Alexandrescu Stadium :: Sibiu - Liceul Bruckenthal :: Timisoara - Politecnico Timisoara Stadium | **RUSSIA** Kaliningrad - MOST - Public Space :: Kazan - Kazan Arena :: Krasnodar - Basketball Sporthall :: Moscow - Fiba



Europe 3X3 Tour ::: Moscow - Luzhniki Olympic Stadium ::: Mytishchi-Moscow - Mytishchi Arena ::: St. Petersburg - Yubileiny Sports Palace ::: St. Petersburg - Zenit Academy | **RWANDA** Kigali - Kigali Arena | **SAUDI ARABIA** Burayda - Al Taawoun Sports Club ::: Madina - Alansar Club ::: Riyadh - Hilal Club | **SERBIA** Aleksinac - Src Srca | **SENEGAL** Dakar - Senegal Arena | **SINGAPORE** Singapore - Sportshub | **SLOVAKIA** Piešťany - Diplomat Arena | **SLOVENIA** Celje - Arena Petrol ::: Domzale - Stadium NK Domzale ::: Koper - Bonifica Arena ::: Koper - Stadium Bonifica ::: Kranj - Stanko Mlakar stadium ::: Ljubljana - Fiba Europe 3X3 Tour ::: Ljubljana - Stozice Arena ::: Maribor - Vrt Stadion ::: Murska Sobota Fazanerija City Stadium | **SOUTH AFRICA** Johannesburg - Wembley Basketball Stadium | **SPAIN** Alicante - Onil 3X3 ::: Canary Island - Fiba Europe 3x3 Tour ::: Cartagena - Palacio de los Deportes ::: Ibiza/San Antonio de P. - Complejo polideportivo Can Coix ::: Las Palmas De Gran Canaria Fiba Europe 3X3 Tour ::: Valencia - Levante Union Deportiva Stadium | **SWEDEN** Solna - Friends Arena ::: Stockholm - Stockholms Olympiastadion | **SWITZERLAND** Mies - Skatepark et Basket 3x3 | **TUNISIA** Rades - FIBA AfroBasket 2017 ::: Tunis - Salle Omnisport 'El-Gorjani' ::: Tunis - Palais des Sports El Menzah | **TURKEY** Antalya - Antalya Arena ::: Istanbul - Cebeci Sport Hall ::: Rize - Rize Yeni Kapali Spor Salonu ::: Yalova - Yalova Sport Hall | **U.A.E.** Abu Dhabi - Al-Nahyan Stadium ::: Abu Dhabi - Mohamed Bin Zayed Stadium ::: Al Ain - Sheikh Khalifa International Stadium | **UKRAINE** Donetsk - Donbass Arena ::: Kiev - Sport Palace Kiev | **UNITED KINGDOM** London - Nike Regal Centre ::: London - Ravenscourt Park ::: London - University of East London ::: Manchester - Manchester University | **VENEZUELA** Varga - Ill Beach Sudamerican Games Varga.



## **SPORT SYSTEM SRL**

**Via del Lavoro, 2 (z.i.)  
31020 San Fior (TV)  
Italy**

**Tel. Ph. +39 0438 401247**

**info@sportssystem.it  
www.sportssystem.it**



**@SportSystemSportsEquipment**

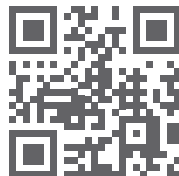

[www.sportssystem.it](http://www.sportssystem.it)